

Analytical and Measuring Instruments for Rechargeable Lithium-ion Batteries

Rechargeable Lithium-Ion Battery Evaluation

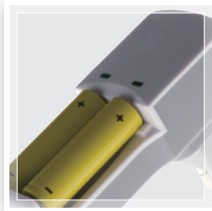
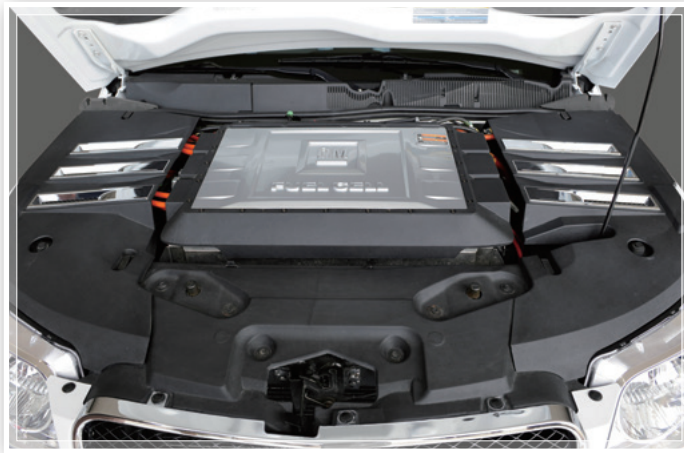
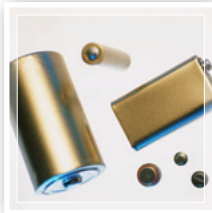

What Are Lithium-ion Rechargeable Batteries?

The lithium-ion rechargeable battery is a relatively new type of battery that was first used in the early 1990s. With their high voltage and high energy density, these batteries are widely used for consumer electronics applications, such as mobile phones and laptop computers.

Due to enhanced consumer concerns for the environment and fuel savings, the automobile industry has also been developing these batteries for hybrid vehicle (HV) and electric vehicle (EV)

applications, which should lead to enhanced output, efficiency, and performance.

As a leading manufacturer of a broad range of analytical and testing instruments, Shimadzu provides a variety of solutions that contribute to research, development, and quality control of lithium-ion rechargeable batteries as they become more widely used in consumer electronics and eco-cars.

Examples of Products Containing Lithium-ion Rechargeable Batteries

Transport devices

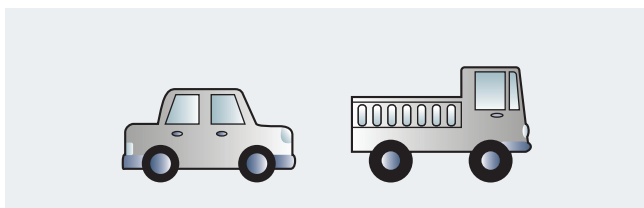

Communications devices



IT devices

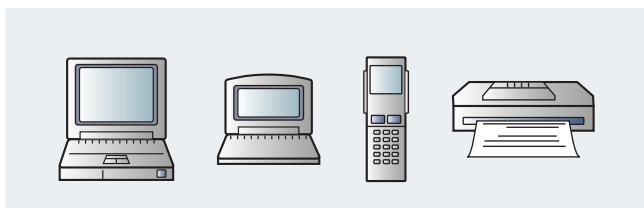

AV devices

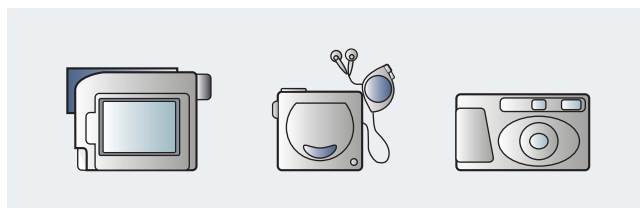

Working Principle of Lithium-ion Rechargeable Batteries

Charging

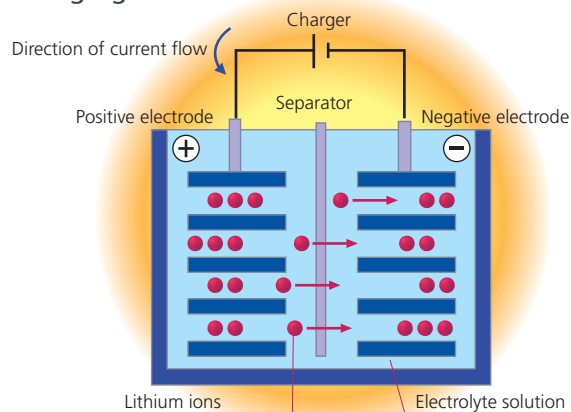

Lithium ions in the lithium compound (positive electrode material) pass through the separator and into the layers in the carbon negative electrode material, resulting in a charging current flow.

Discharging

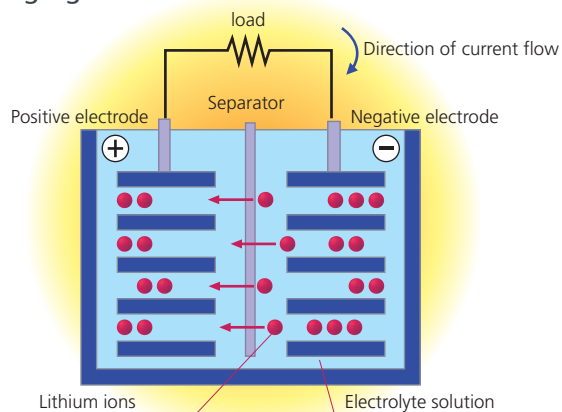

Lithium ions between the layers in the carbon negative electrode material pass through the separator and into the lithium compound (positive electrode material), resulting in a discharging current flow.

How the Lithium-ion Rechargeable Battery Works

Appearance

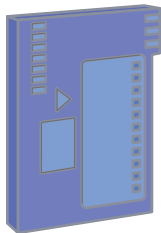

Mobile phone battery (single cell)

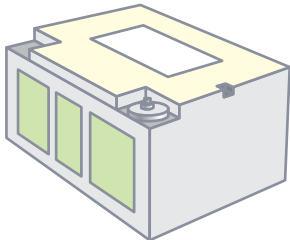

Vehicle battery (module)

Basic Structure

A lithium-ion rechargeable battery has a three-layer construction, with a separator sandwiched between the positive and negative electrode sheets that are wrapped in an elliptical form. This structure is immersed in an electrolyte solution and sealed in a metal casing.

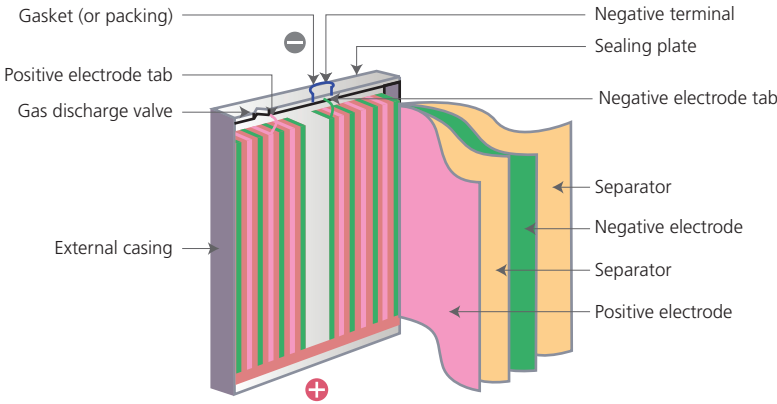

Cross-Sectional Diagram

Electrode Schematic Diagram

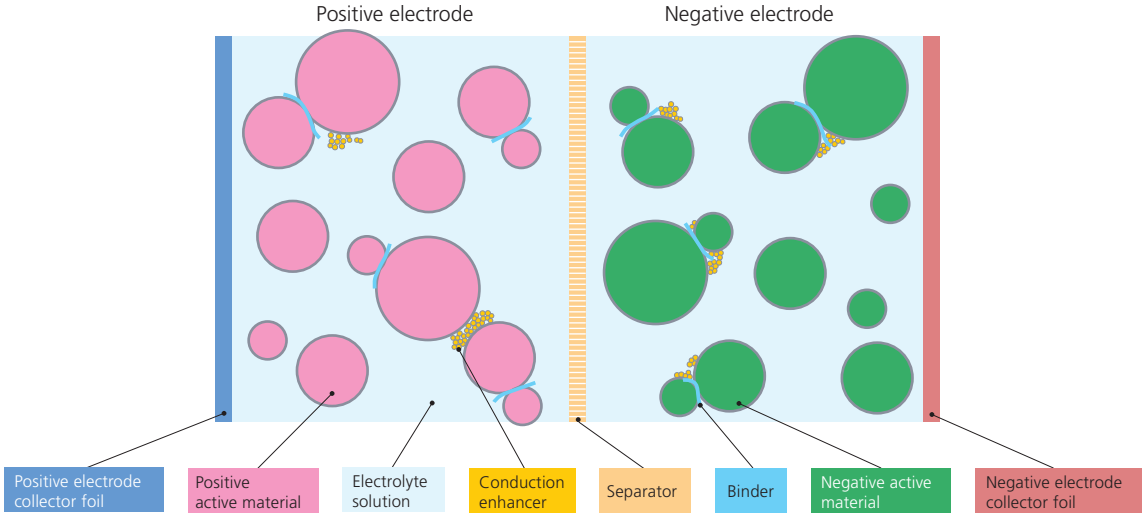

Rechargeable Lithium-Ion Battery Evaluation

Electrodes

Active Materials

ICP Emission Spectrometer

ICP Series

Offers highly sensitive and accurate compositional analysis of materials and parts, such as electrodes and electrolyte solution. An extensive lineup, from a multi-type system that features low running costs and quickly analyze.

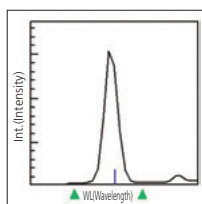

Spectral Line Profile



Sequential X-Ray Fluorescence Spectrometer

LAB CENTER XRF-1800

Permits the non-destructive qualitative analysis of elements in different sample states – solid, powder, or liquid. The FP method can conduct quantitative analysis without a calibration curve. It simplifies quantitation of battery constituent materials from major components to impurities, and provides comprehensive applications, including measurement of minute, 500 μm diameter regions.



Electron Probe Microanalyzer

EPMA-8050G

This instrument allows dispersion confirmation of the positive electrode materials and observation of the distributions of binder and conduction enhancer. It can also evaluate the deterioration of fuel cells by observing the behavior of fluorine in the solid polymer. The EPMA-8050G incorporates a high-resolution electron source for evaluation of the minute amounts of catalyst on the electrodes.



Nano Particle Size Analyzer

SALD-7101

Allows particle size distribution measurements in positive and negative active materials. The SALD-7101 combines laser diffraction and scattering methods with a UV semiconductor laser (375 nm wavelength) to measure particle size distributions from 10 nm to 300 μm. Comprehensive options are available, including a high-concentration sample measuring system and software to acquire data at 1 second intervals.



X-ray Diffractometer

XRD-6100

X-ray diffractometry allows the qualitative analysis of crystalline compounds. It can analyze the crystalline structure, orientation, and size of positive and negative electrode active materials in the battery. It also offers qualitative analysis, crystallinity analysis, and orientation analysis of the separator material. Highly sensitive analysis using the polycapillary optical system is also possible.

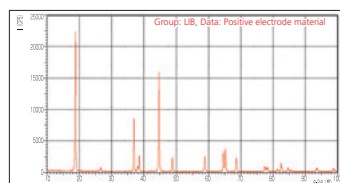

Diffraction Patterns of Positive Electrode Material in a Lithium-ion Rechargeable Battery



KRATOS AXIS-Supra Imaging XPS System

AXIS-Supra

Permits observations of the composition and chemical status of materials on the electrode and separator surfaces at nanometer-order resolution in the depth direction. The XPS system can conduct measurements without pretreatment, irrespective of the sample conductivity. It is effective for evaluating materials characteristics and the degree of surface contamination.

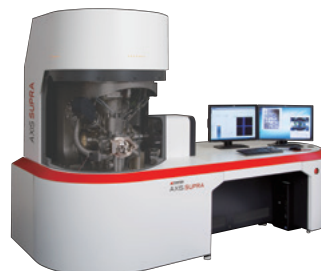

How the Lithium-ion Rechargeable Battery Works

Binder

High-Performance Liquid Chromatograph

Prominence Series

Prominence allows the separation and quantitation of organic substances and ions contained in the electrolyte solution.

The extensive product range supports a wide range of analysis from ppb level to percentage level. In addition to concentration measurements, these instruments can measure the molecular weight distribution of polymers.



Infrared Microscope Measurement System

IRTracer-100

Effective for the composition analysis of binders, electrolytes, and separators. The ATR method virtually eliminates the need for pretreatment and permits analysis of microscopic regions of a sample surface or thin film. The accuracy and operability of the microscope system has been enhanced.



Scanning Probe Microscope

SPM-9700HT

The SPM-9600 easily takes high-magnification 3D images in air or liquid for surface observations of samples from electrodes and semiconductors to separators and electrolyte membranes. Non-conductive objects do not require coating or other pretreatment. The instrument can measure the electrical characteristics of the sample at the probe tip. Upgradeable to environment-controlled SPM.



Electrolyte Solution (Solvent, Electrolyte, Additive)

Gas Chromatograph - Mass Spectrometer

GCMS-QP2020

This instrument is effective for composition analysis of electrolyte membranes, separators, and solvents in the electrolyte solution as well as for component analysis of emitted gases.

In combination with pyrolysis, headspace, or other pretreatment methods, the GCMS-QP2020 can analyze samples in different states. In addition to the commonly used electrospray ionization (EI), negative chemical ionization (NCI) is available as an option to perform highly sensitive and selective analysis.



Gas Chromatograph

GC-2010Plus/2014 Series

These instruments offer highly accurate and sensitive analysis of evolved gases and electrolytes. The GC-2010Plus/2014 supports both packed and capillary columns to analyze a diverse range of samples. Excellent repeatability is assured by the optimized sample injection unit and the electronic flow controller (AFC) that accurately controls the carrier gas up to the high-pressure, high-flow rate regions required for fast analysis.



Rechargeable Lithium-Ion Battery Evaluation

Analytical and Measuring Instruments for Rechargeable Lithium-ion Batteries

Separator

Active Materials

Thermogravimetric Analyzer

DTG-60/60A (TG/DTA) TGA-50/50H (Dedicated TG)

The DTG-60 (TG/DTA) permits measurements of changes in the properties of battery materials under heating.

Incorporates a high-sensitivity, high-accuracy balance rivaling a dedicated thermogravimeter.

The unique top-pan differential construction achieves the stable baseline essential for TG/DTA. The suspension-type TGA-50 (dedicated thermogravimeter) offers high-capacity, high-sensitivity thermogravimetry that allows trace moisture measurements to 100 ppm.



Differential Scanning Calorimeter

DSC-60 Plus/60 Plus A

The DSC-60/60A is effective for evaluation of separator melting, deterioration or decomposition of the electrolyte, and other thermal properties under heating. It features 1 μm max, low noise level, high sensitivity, and high resolution, and it incorporates liquid nitrogen cooling, which simplifies measurements during the cooling process.

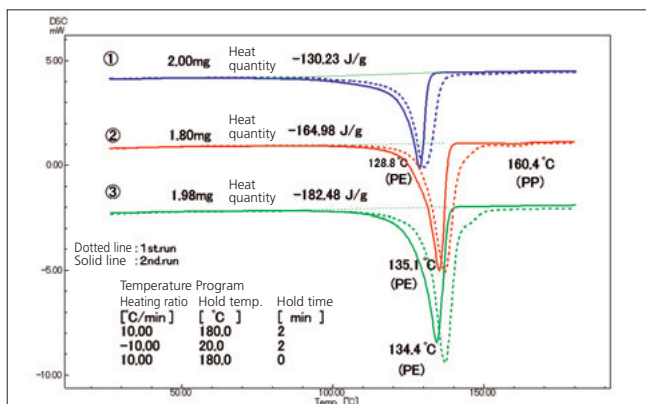

DSC Measurement of Separator Melting

Thermomechanical Analyzer

TMA-60/60H

An effective tool for evaluation of the expansion and contraction behaviors of separators and other battery materials under heating. The new digital displacement sensor reduces temperature drift to achieve stable measurements. Achieves excellent linearity despite the wide ± 5 mm measurement range.

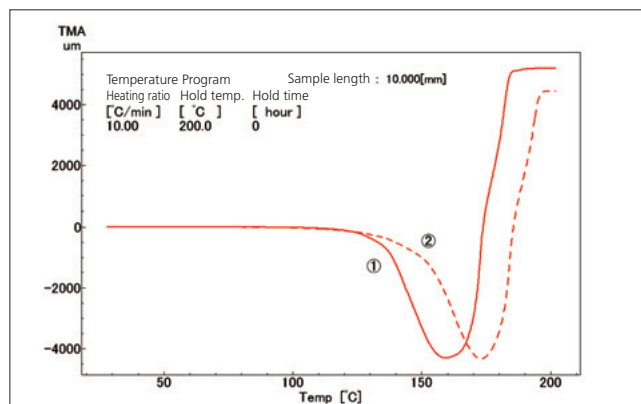

TMA Measurement of Separator Contraction Behavior

Cells (Single-Cell, Module)

Binder

Servopulser Fatigue Testing Machines

EHF-U Series

This machine applies accurate loads (test force, displacement) at high speeds to evaluate the durability of batteries and their constituent materials under repeated stress. It permits nail penetration testing and crush testing. This series supports testing using a thermostatic chamber. It offers an electromagnetic model for low-capacity applications in addition to the hydraulic models.



Universal Testing Machines

AG-X plus

These are the most basic mechanical strength testing machines. Select from the wide range of test jigs to conduct tensile, compression, or bending testing on batteries and battery materials. Automated control allows even novices to obtain reliable data. A thermostatic chamber can be attached to control the test temperature and humidity.

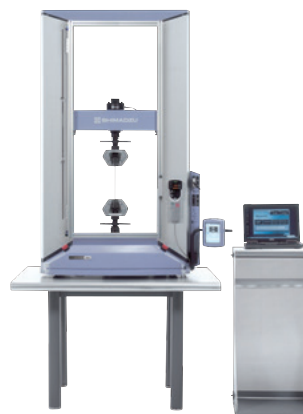

Microfocus X-ray CT System

inspeXio SMX-225 CT FPD HR

Industrial CT systems provide a non-destructive method to obtain internal observations of objects. A CT system with submicron-level resolution is effective for clearly identifying the internal status of multiple electronic components. These systems are employed for final quality control in the battery production process.

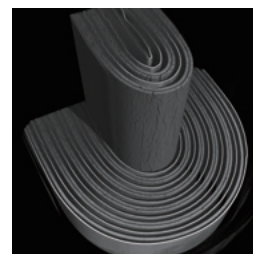
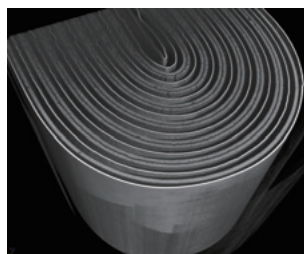
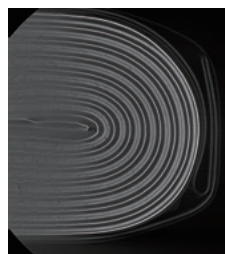
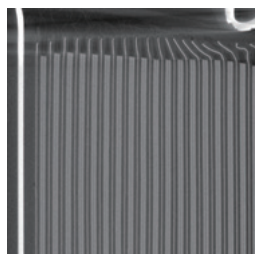
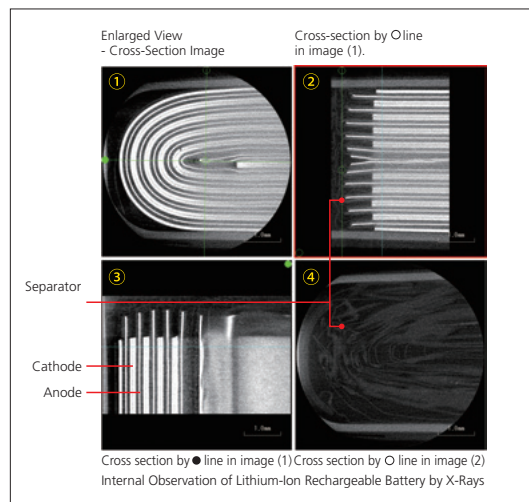

Lithium-ion Rechargeable Battery Manufacturing Process

Lithium-Ion Rechargeable Battery

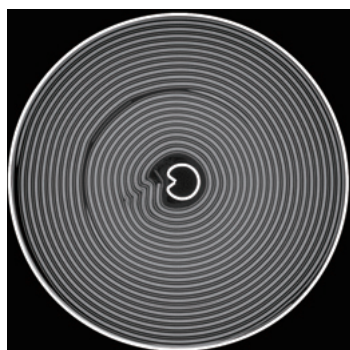

Cross-Sectional Image

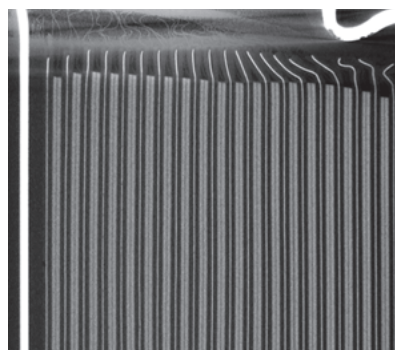

Oblique Image

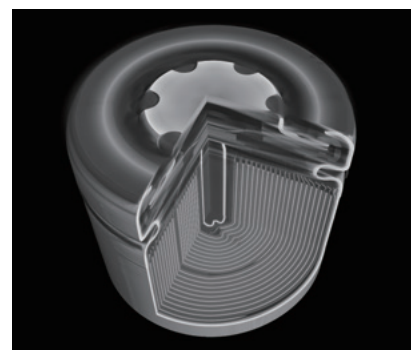

VR Image

Rectangular Lithium Polymer Battery (for Smartphones)

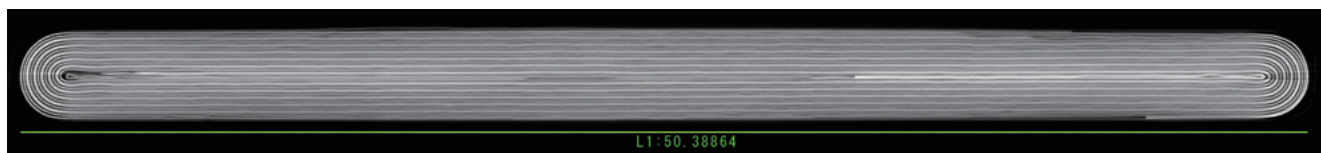

Cross-Sectional Image

Lithium-ion Rechargeable Battery Testing Instrument Matrix

Part	Material	Commonly Used Components	Test Items (Instrument)
Positive electrode	Active material	LiCoO ₂ (lithium cobalt oxide) Mn or Ni may be used instead of Co.	Composition (ICP, XRF) Crystallinity (XRD) Particle size (particle size analyzers)
	Binder	Vinylidene fluoride (polyvinylidene fluoride (PVDF))	Electron state (XPS) Molecular weight distribution (GPC) Surface status (SPM)
	Conduction enhancer	Carbon (carbon black, acetylene black, graphite, etc.)	Composition (FTIR) Crystallinity (XRD)
Negative electrode	Active material	Carbon, graphite	Crystallinity (XRD)
	Trace additive	Li, P, Cu, Na, Co, Ca, K, etc.	Particle size (particle size analyzers)
	Binder	SBR (styrene-butadiene rubber) CMC (carboxymethylcellulose), PVDF also used previously	Composition (ICP)
Separator		Polyolefins (high-density polyethylene)	Structure (FTIR) Thermal characteristics (TG)
Electrolyte solution	Solvent	Carbonate ester, carboxylate ester, ether	Composition (GCMS, GC)
	Electrolyte	LiPF ₆ , LiBF ₄	Composition (ICP)
	Additive	Vinylene carbonate	Composition (GCMS)
Cells Single-cell, module			Compression strength (universal testing machine) Nail penetration testing (materials testing machine) Internal observations (X-ray CT system)



For Research Use Only. Not for use in diagnostic procedures.

This publication may contain references to products that are not available in your country. Please contact us to check the availability of these products in your country.

Company names, products/service names and logos used in this publication are trademarks and trade names of Shimadzu Corporation, its subsidiaries or its affiliates, whether or not they are used with trademark symbol "TM" or "®".

Third-party trademarks and trade names may be used in this publication to refer to either the entities or their products/services, whether or not they are used with trademark symbol "TM" or "®".

Shimadzu disclaims any proprietary interest in trademarks and trade names other than its own.

The contents of this publication are provided to you "as is" without warranty of any kind, and are subject to change without notice. Shimadzu does not assume any responsibility or liability for any damage, whether direct or indirect, relating to the use of this publication.

Shimadzu Corporation

www.shimadzu.com/an/