

Solution for Method Development and Analytical Quality by Design

LabSolutions MD



Improve the Efficiency of Analytical Condition Screening with Experimental Design

Analytical condition settings can be efficiently screened in fewer attempts using an experimental process design to collect data.

Screening Phase

Optimization Phase

Use Design Space to Visualize the Robustness of Analysis Methods

The software can graph factor-response relationships and suggest the most robust analytical conditions. It even supports chromatogram simulation.

Validation Phase

Centrally Manage All Experiment Results in a Database

The software outputs a report that summarizes the experimental design, design space, chromatograms, and other relevant information. It also manages the information in a database to ensure data integrity.

AQbD

Improving Efficiency of the Entire Method Development Workflow

LabSolutions™ MD improves method development efficiency by taking an Analytical Quality by Design (AQbD) approach.

This software efficiently develops highly reliable analysis methods by configuring mobile phases, columns, and other parameters using an analysis function that automatically generates analysis schedules with the experimental design method and a data analysis function that plots a design space and predicted chromatogram.

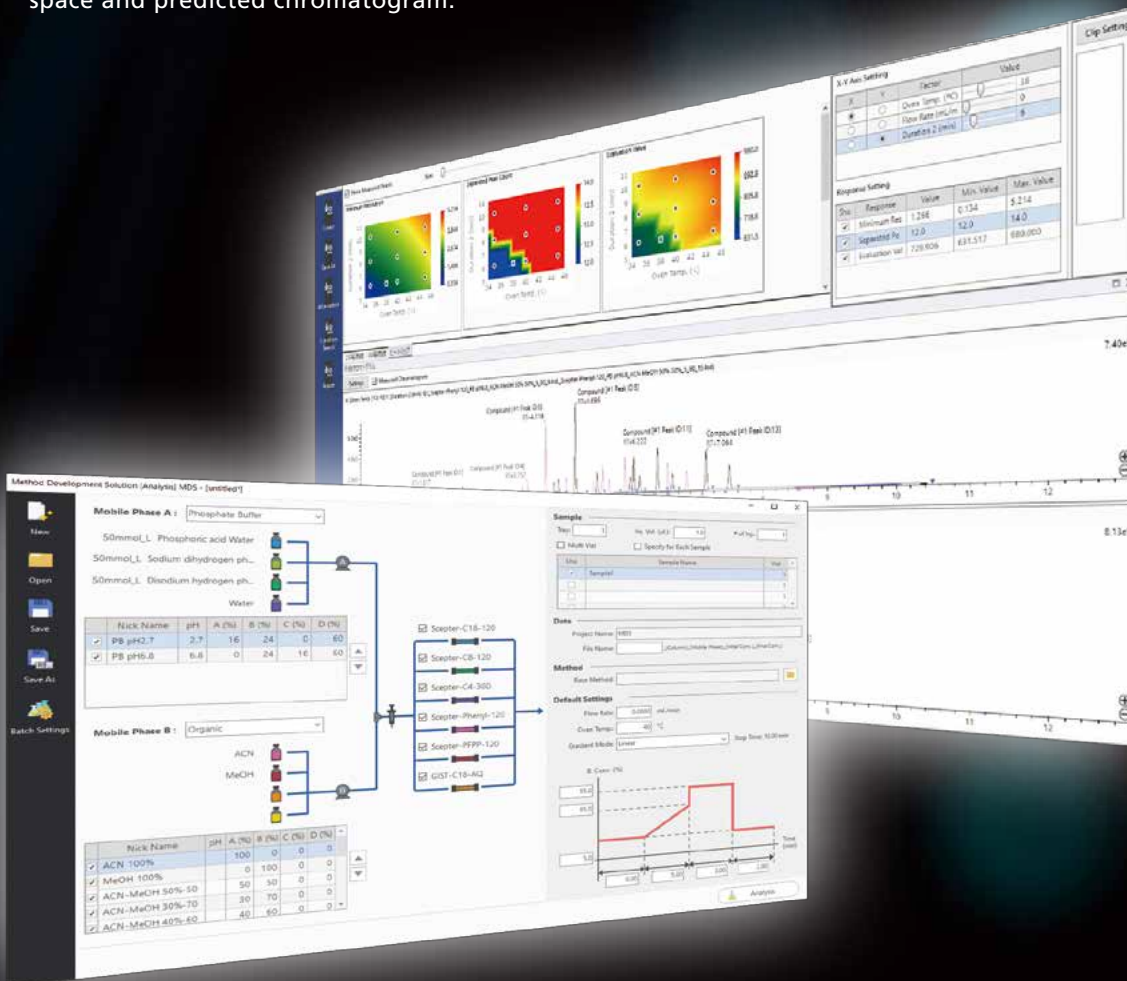

LabSolutions MD Features

for Each Phase of Analysis Method Development using the AQbD Approach

All steps involved in the screening, optimization, and validation phases of the analysis method development workflow can be completed using LabSolutions MD. These include analyzing samples using experimental design, building a design space using the analytical results, and evaluating robustness after deciding the optimal analytical conditions.

Column Nick Name	MPA pH	MPB A (%)	Response	
			Evaluation Value	Minimum Resolution
Scepter-Phenyl-120	6.8	50	546.000	3.224
Scepter-C8-120	6.8	0	469.894	0.093
GIST-C18-AQ	2.7	0	465.124	1.075
GIST-C18-AQ	6.8	50	443.580	1.826
Scepter-C8-120	6.8	50	436.241	0.026
Scepter-Phenyl-120	2.7	50	419.659	1.743
Scepter-C18	2.7	0	419.338	1.518

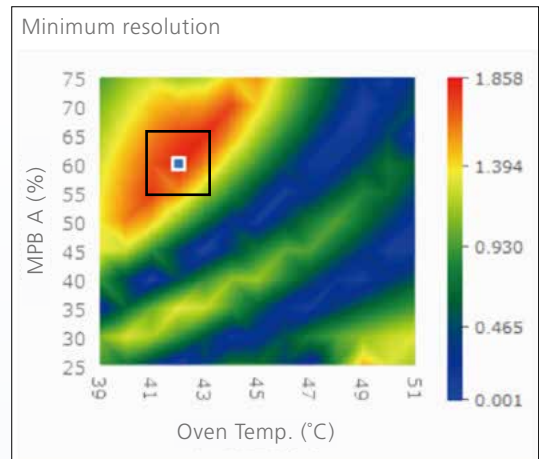

Quickly Screen for Optimal Analytical Conditions by Ranking Chromatograms ▶ p.9

Visualize the Most Robust Analytical Conditions Using the Design Space ▶ p.11



Screening Phase

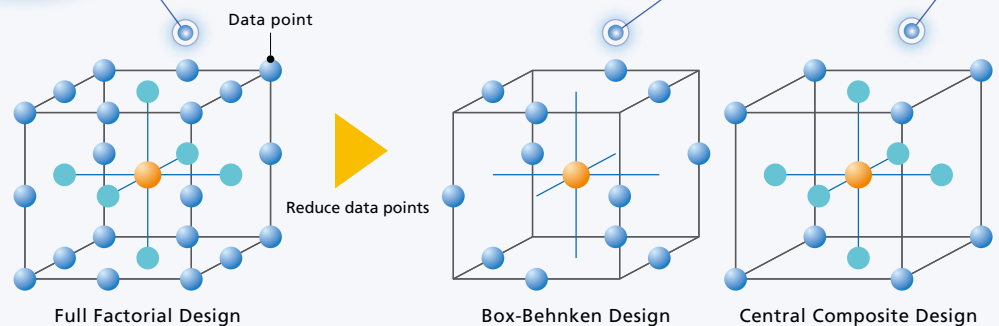

Reduce Data Points Using Experimental Design ▶ p.10

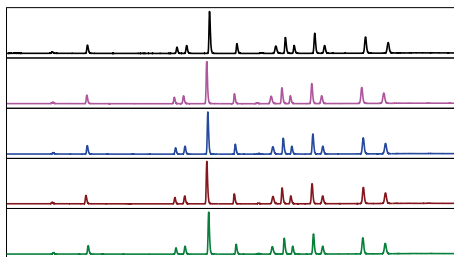

Confirming Robustness ▶ p.13

Validation Phase

Optimization Phase

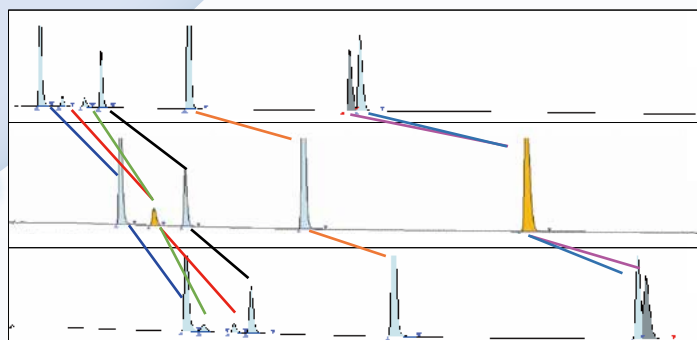

Automatically Identify Compounds by Peak Tracking ▶ p.10

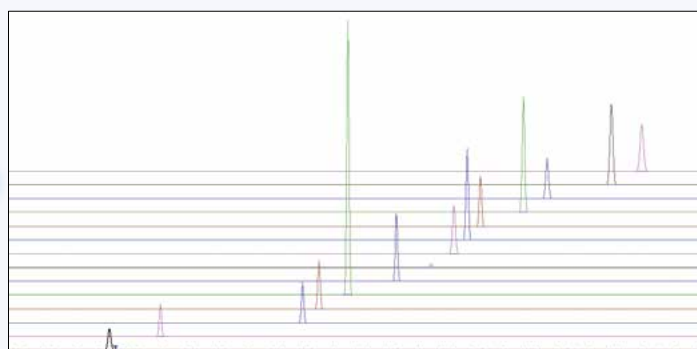

Chromatogram Simulation ▶ p.11



**ANALYTICAL
INTELLIGENCE**

Automated support functions utilizing digital technology, such as M2M, IoT, and Artificial Intelligence (AI), that enable higher productivity and maximum reliability. Allows a system to monitor and diagnose itself, handle any issues during data acquisition without user input, and automatically behave as if it were operated by an expert. Supports the acquisition of high quality, reproducible data regardless of an operator's skill level for both routine and demanding applications.

Workflow of AQbD Approach for Method Development

The International Council for Harmonisation of Technical Requirements for Pharmaceuticals for Human Use (ICH) suggests the AQbD approach for method development. It is recommended to acquire data by conducting efficient experiments, such as with the use of experimental design, verifying the parameters that have a large effect on analytical results, and then building a design space to understand the effective domain of the parameters with respect to the analysis results. This risk-based approach ensures the development of robust, low-risk methods without relying on user experience.

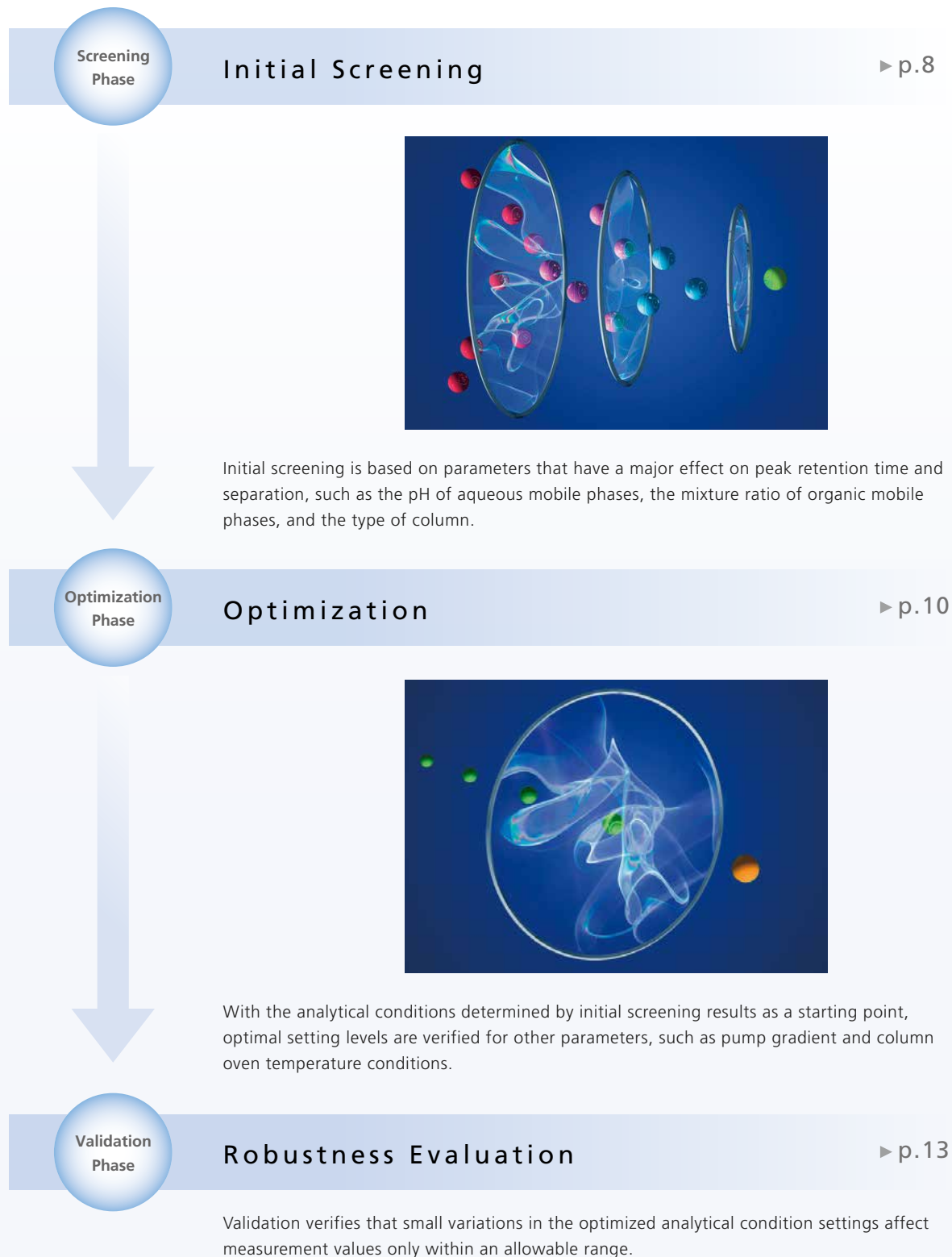

The following pages describe the various functions of LabSolutions MD software based on an example of using the workflow indicated on the left page to screen analytical conditions for simultaneous analysis of small-molecule drugs. For details, click the icon below and refer to the Technical Report entitled "Efficient method development based on Analytical Quality by Design with LabSolutions MD software (C190-E284)".



Analytical Conditions for Simultaneous Analysis

Analytes (12 types of small-molecule drugs) 1: Probenecid 2: (S)-(+)-Naproxen 3: Acetylsalicylic acid 4: Diclofenac sodium 5: Papaverine hydrochloride 6: Dibucaine hydrochloride 7: Amitriptyline hydrochloride 8: Indometacin 9: Antipyrine 10: Lidocaine 11: Quinidine 12: Metoclopramide	Mobile phase: Pump A: A: 20 mmol/L (Sodium) phosphate buffer (pH 2.7) B: 20 mmol/L (Sodium) phosphate buffer (pH 6.8)	2 aqueous types	
	Pump B: A: Acetonitrile B: Acetonitrile / Methanol = 1 : 1 C: Methanol		3 organic types
		Column: 1: Shim-pack Scepter™ C18-120 (100 mm × 3.0 mm I.D., 1.9 μm) 2: Shim-pack Scepter C8-120 (100 mm × 3.0 mm I.D., 1.9 μm) 3: Shim-pack Scepter C4-300 (100 mm × 3.0 mm I.D., 1.9 μm) 4: Shim-pack Scepter Phenyl-120 (100 mm × 3.0 mm I.D., 1.9 μm) 5: Shim-pack Scepter PFPP-120 (100 mm × 3.0 mm I.D., 1.9 μm) 6: Shim-pack™ GIST C18 AQ HQ (100 mm × 3.0 mm I.D., 2.0 μm)	6 column types
		Analytical condition: Time program : B.Conc. 5%(0 min)→80%(8.01-11 min)→5%(11.01-15 min) Flow rate : 0.7 mL/min Inj.vol. : 1.0 μL Temperature : 40 °C Detection : Max plot 220- 400 nm (SPD-M40)	Basic conditions



STEP 1 Initial Screening ▶ p.8

Using full factorial design, select the optimal combination of mobile phase (from 2 aqueous types and 3 organic types) and column (6 types).

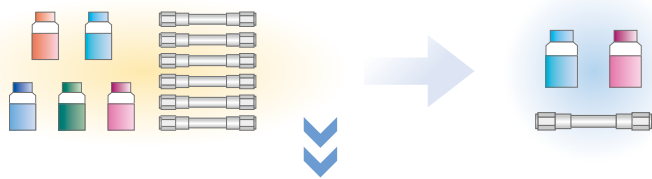

STEP 2 Optimization ▶ p.10

Create a design space in terms of three parameters: organic mobile phase mixture ratio, pump gradient conditions, and column oven temperature. Then specify analytical conditions by determining the optimal level of each.

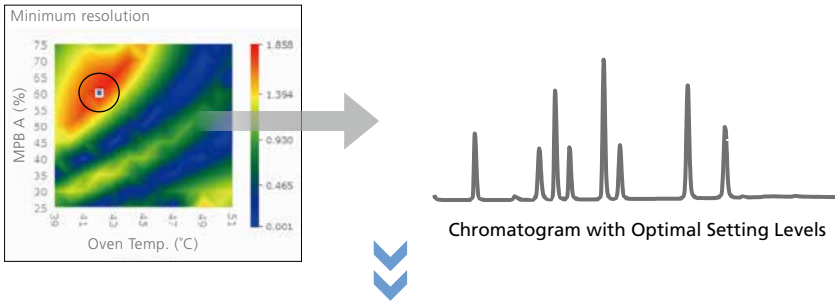

STEP 3 Robustness Evaluation ▶ p.13

Using iterative experimental design, evaluate robustness with respect to variations in the organic mobile phase mixture ratio and column oven temperature levels.

Use the two types of aqueous mobile phases, three types of organic mobile phases, and six types of columns to acquire a total of 36 data points (full factorial design) for screening mobile phase and column conditions.

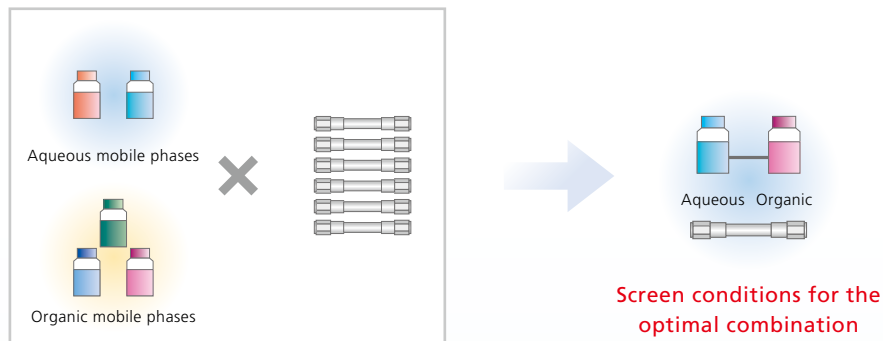

Easily Creates Analysis Schedules with Experimental Design

The process of creating the vast number of method files and analysis schedules required for screening can be completed quickly by simply following steps (1) to (5) below. The mobile phase and column can be selected with a single click and a comprehensive schedule reflecting column equilibration and blank analysis is generated automatically. In addition to improved operational efficiency, this process can reduce human errors. The experimental design can also be selected with a single click.

(1) Select the mobile phase.

(2) Select the column.

(3) Enter sample information

(4) Select the experimental design.

(5) Enter gradient conditions (including pump flowrate and oven temperature).

Click the icon on the right for an example of automated pH screening of mobile phase.



Automation of Mobile Phase Preparation with Mobile Phase Blending Function

The mobile phase blending function can improve the efficiency of mobile phase preparation by automatically preparing mobile phases based on factors such as the user-specified pH level or the mixture ratio of organic mobile phase, with only a few types of mobile phases prepared in advance. This not only greatly reduces the burden of manual preparation but also prevents human errors in blending.

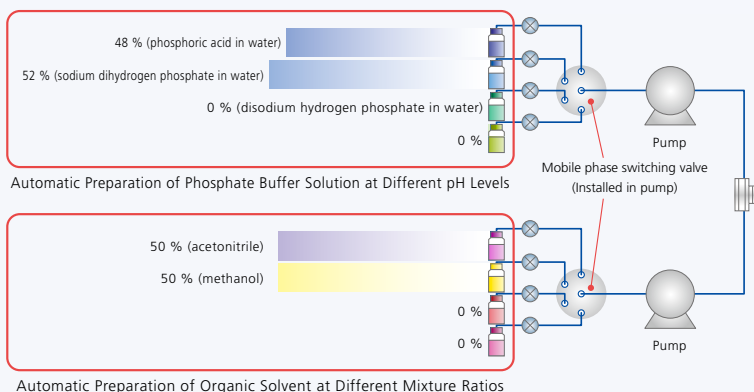

Automatic Mobile Phase Preparation with Mobile Phase Blending Function

Quickly Find Optimal Conditions

Because screening generates as many chromatograms as the number of conditions considered, they must be evaluated to determine which is optimal. If all the chromatograms had to be scrutinized by a human, it would be very tedious. LabSolutions MD can quickly and easily find optimal analytical conditions using equation (1) below to quantitatively evaluate the separation status resulting from each set of analytical conditions.

$$E = P \times (R_1 + R_2 + \dots + R_{P-1}) \dots \text{(Eq. 1)}$$

The evaluation value (E) is calculated as the number of peaks detected (P) multiplied by the sum of the separation level (R) for all peaks.

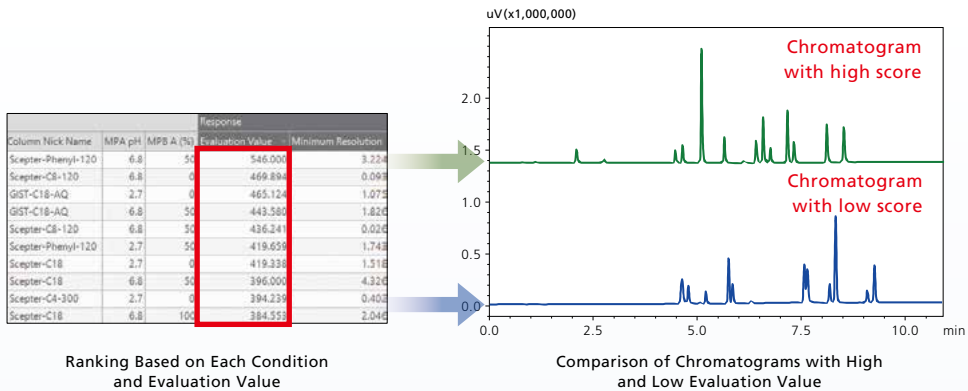

Target Peak Resolution can be used to evaluate the resolution on a specific peak while Evaluation Value considers all the peaks detected.

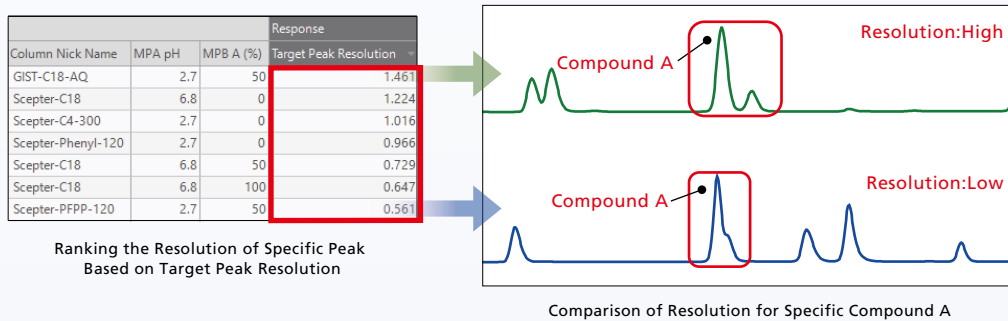

Identification of the Parameters that have a Large Impact on Separation Using Analysis of Variance

How much each parameter used for screening affects separation can be confirmed by analysis of variance. Identifying the parameters that have a large effect on separation can reduce the number of target parameters to be optimized during the analysis method optimization phase, which enables even more efficient experiments.

Because factors with a p-value of 0.05 or less can be assumed to have a variance value that is 95 % of the error variance, it is safe to assume that, if results differ for each setting level, then that factor has a large effect on separation. The analysis can also confirm the effect of interactions.

* The probability that the test statistic calculated under the null hypothesis is greater or less than this value is referred to as the p-value.

Display Plots	Effect	SSR	df	MS	F Value	p Value
<input checked="" type="checkbox"/>	MPA pH x MPB B (%)	44817.9	2	22408.9	6.72	0.0141
<input checked="" type="checkbox"/>	Column Nick Name	66312.0	5	13262.4	3.98	0.0302
<input checked="" type="checkbox"/>	Column Nick Name x MPA pH	35853.2	5	7170.6	2.15	0.142
<input checked="" type="checkbox"/>	Column Nick Name x MPB B (%)	50149.0	10	5014.9	1.50	0.265
<input checked="" type="checkbox"/>	MPB B (%)	9123.7	2	4561.9	1.37	0.298
<input checked="" type="checkbox"/>	MPA pH	3243.6	1	3243.6	0.973	0.347
	Error	33336.5	10	3333.7		
	Total	242835.8	35			

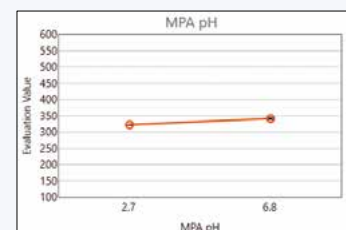

Using Analysis of Variance to Determine How Much Each Parameter Affects Separation

Results of Analysis of Variance

Reduce the Number of Data Points Using Experimental Design

Box-Behnken design and central composite design can shorten analysis times because they require fewer data points than full factorial design. For example, if determining the three optimal levels for the organic mobile phase mixture ratio, pump gradient conditions, and column oven temperature, full factorial design requires 27 data points ($3 \times 3 \times 3$) for optimization whereas Box-Behnken design requires 13 points and central composite design requires 15 points.

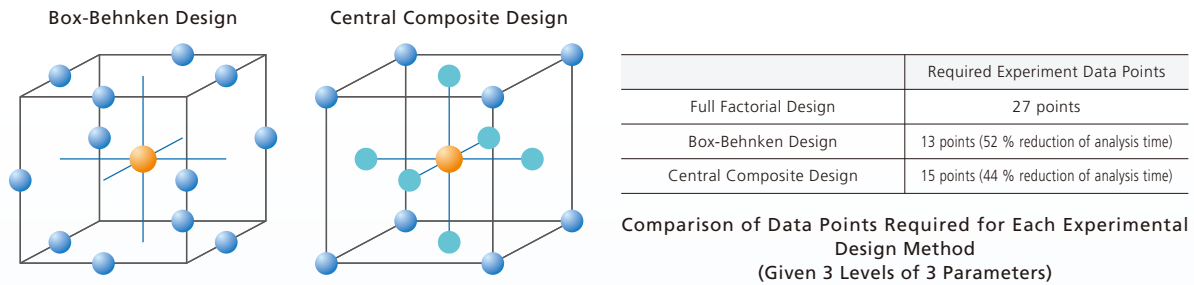

Automatic Identification of Compounds by Peak Tracking (i-PeakTracer™)

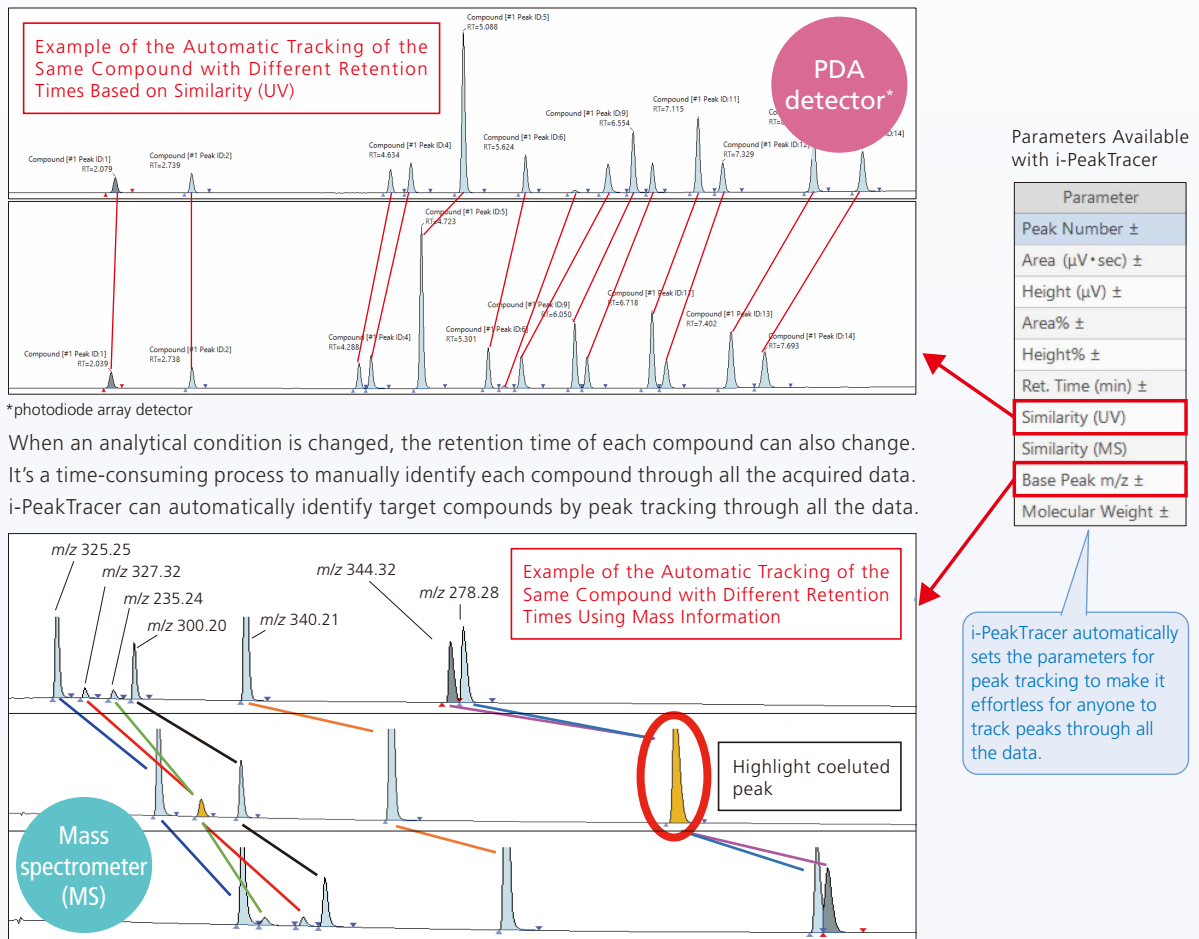

i-PeakTracer automatically sets the parameters for peak tracking to make it effortless for anyone to track peaks through all the data.

Parameter
Peak Number ±
Area (µV·sec) ±
Height (µV) ±
Area% ±
Height% ±
Ret. Time (min) ±
Similarity (UV)
Similarity (MS)
Base Peak m/z ±
Molecular Weight ±

By using mass information, the software can perform highly reliable peak tracking even for compounds with similar UV spectra. Further, peaks suspected of coeluting are highlighted in orange.

NEW

For oligonucleotides, peptides, and other medium-sized molecular compounds, peak tracking can be performed using molecular weights estimated by deconvolution.

Click the icon on the right for an example of efficient method development using single quadrupole mass spectrometer.

Click the icon for an example of optimal method development (peak tracking based on molecular weights) for oligonucleotides.



Visualize the Most Appropriate Analytical Conditions by Design Space



After the pH level of the aqueous mobile phase and column are selected in the screening phase, analytical conditions are further optimized by considering the mixture ratio of the organic mobile phase (30, 40, 50, 60, 70 %), oven temperature (35, 40, 45 °C), and final concentration of gradient program (75, 80, 85 %). The effect these parameters have on separation is shown in the design space with the mixture ratio of organic mobile phase on the vertical axis and oven temperature on the horizontal axis. The design space can visualize not only resolution but also symmetry factor, theoretical plate, and other responses.

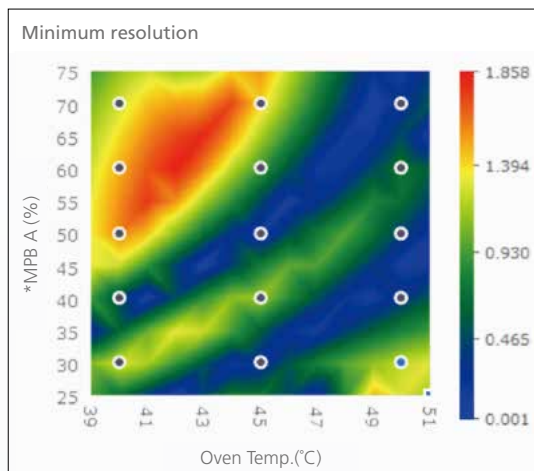

Design Space of Minimum Resolution
(Gradient Final Concentration: At 75 %)

* MPB A : acetonitrile

The black dots in the figure are points where the analysis was implemented.

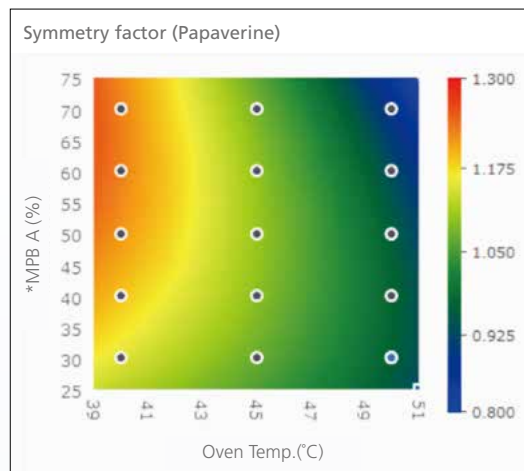

Design Space of Symmetry Factor (Papaverine)
(Gradient Final Concentration: At 75 %)

* MPB A : acetonitrile

The black dots in the figure are points where the analysis was implemented.

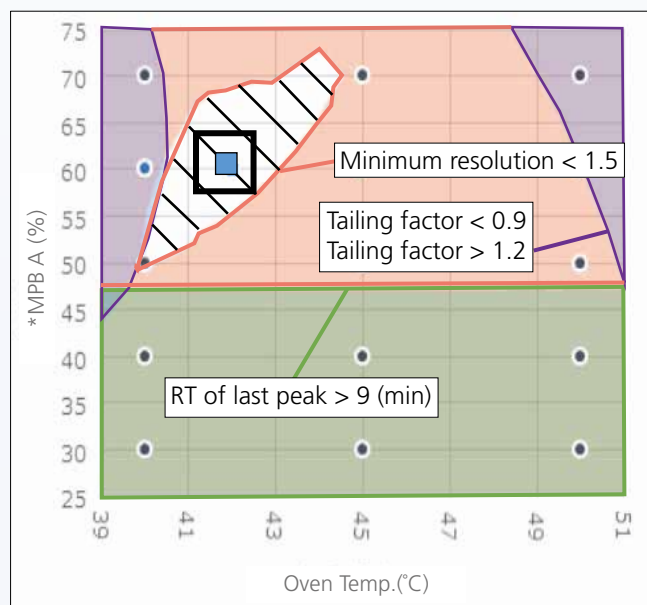

Overlay of the Design Spaces for Minimum resolution, symmetry factor,
and the Last Peak Retention Time

(Gradient Final Concentration: At 75 %)

* MPB A : acetonitrile

The black dots in the figure are points where the analysis was implemented.

The optimal analytical conditions can be searched for more efficiently by overlaying the above-mentioned two design spaces. As an example, selecting the criteria as a minimum resolution of 1.5, a tailing factor (Papaverine) between 0.9 and 1.2, and a maximum retention time for the last peak of 9 minutes, the conditions region where these are satisfied is shown in the figure to the left by overlaying the design spaces.

- Region with a minimum resolution less than 1.5
- Region with a symmetry factor less than 0.9 or more than 1.2
- Region with a last peak retention time longer than 9 minutes
- Conditions Region Satisfying the Criteria

Search for Point that Satisfy Robustness	
Factor	Tolerance
Oven Temp. (°C)	1
MPB A (%)	5
Final Conc. (%)	5

If permitted values for variations in the parameters (factors) are entered, the software will propose robust analytical conditions (the black rectangle in the figure at left) that satisfy the permitted range.

Overlaying the design spaces makes it evident that the optimal analytical conditions are as follows: organic solvent mixture ratio of 60 %, column oven temperature of 42 °C, and gradient final concentration of 75 %. It is possible to search not only for the resolution and the symmetry factor, but also the optimal analytical conditions considering the analysis time. Robust analytical conditions can be specified without relying on intuition or experience by utilizing design space.

By clicking any point in the design space (e.g. point A : blue square in the black circle), a simulated chromatogram can be displayed. This function allows quickly checking how the separation will change without running an analysis.

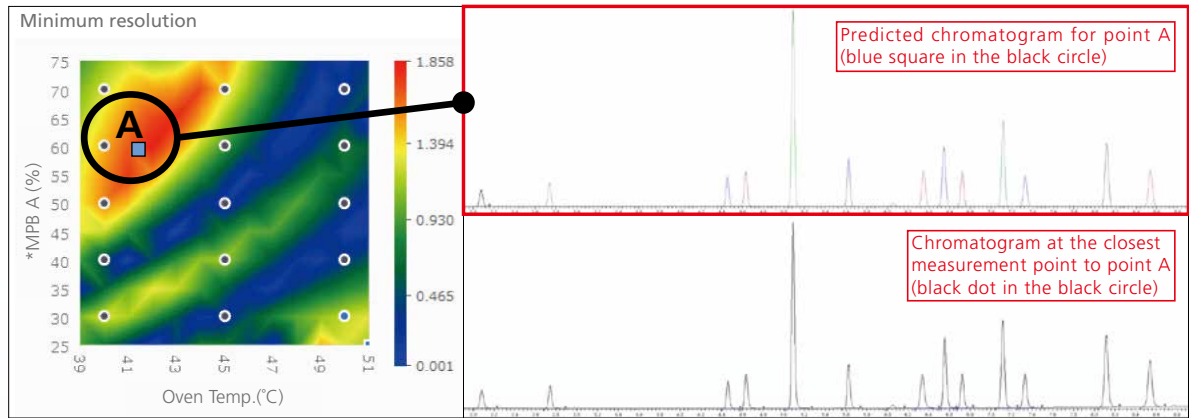

* MPB A : acetonitrile
The black dots in the figure are points where the analysis was implemented.

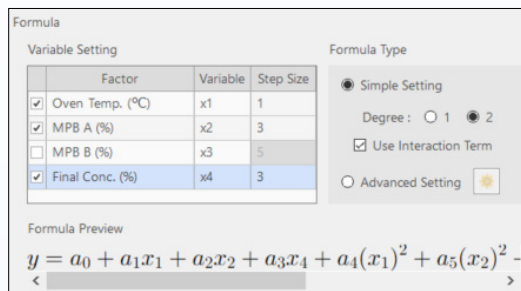

The regression model for the peak width and retention time used in the prediction can be set freely, supporting the creation of high-accuracy design spaces. (Figure at left)

Example of Efficient Method Optimization Using Design Space

Design space is able to visualize the condition that provides the resolution and robustness needed for method development. The following applications show examples of efficient method optimization for analysis of oligonucleotides and a monoclonal antibody. For details, click the icon below and check the Application News.

Efficient Method Development of Oligonucleotides by Reversed-Phase Ion-Pair Chromatography

Application 

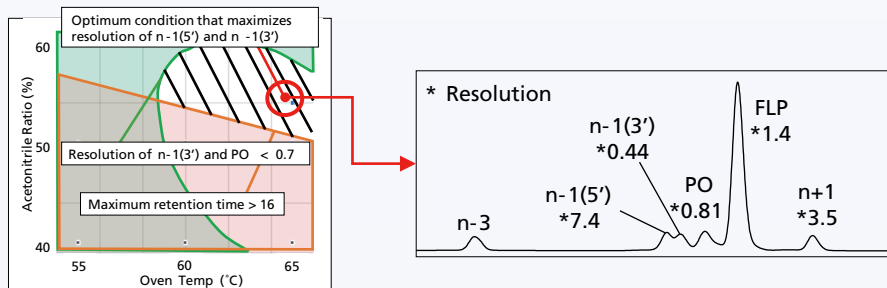

Efficient Method Development of Monoclonal Antibody Size Variants by Size Exclusion Chromatography

Application 

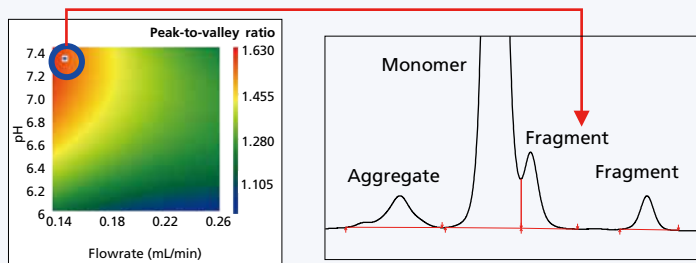

Evaluating Robustness Using Sequential Experimental Design

LabSolutions MD can create a sequential experimental design to perform robustness evaluation. Robustness evaluation is important to understand how variations in parameters will affect results and ensure the reliability of methods. LabSolutions MD creates a sequential experimental design automatically by changing the parameters of an optimized method in a small range to evaluate the robustness. In this example, the mixture ratio of organic mobile phase was changed by 1 % (59, 60, 61 %) and oven temperature by 1 °C (41, 42, 43 °C) (white circles in the right figure) to verify the effect on separation.

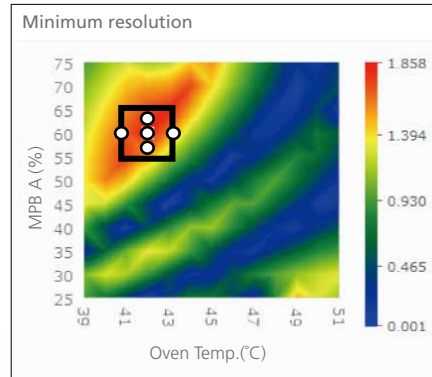

Below shows chromatograms obtained for robustness evaluation. Varying the parameters had little effect on separation, showing robustness of the optimized method constructed by design space.

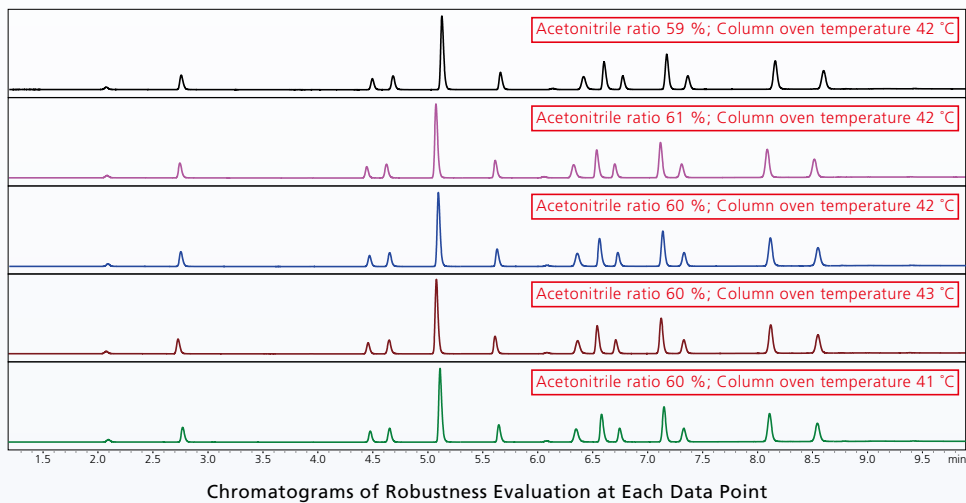

Robustness Evaluation across Different Column Lots

Applying design spaces to different lots of columns improves the efficiency of robustness evaluation. The figures below show the design spaces of resolution with columns from three different lots for the analysis of ketoprofen and its impurities. In all of the design spaces, it is evident that the regions with high resolution (orange and red) are distributed over the entire area, confirming that the optimized conditions are highly robust regardless of the column lot.

For details, refer to Application News "Efficient Method Development on Pharmaceutical Impurities based on Analytical Quality by Design (01-00335-EN)".

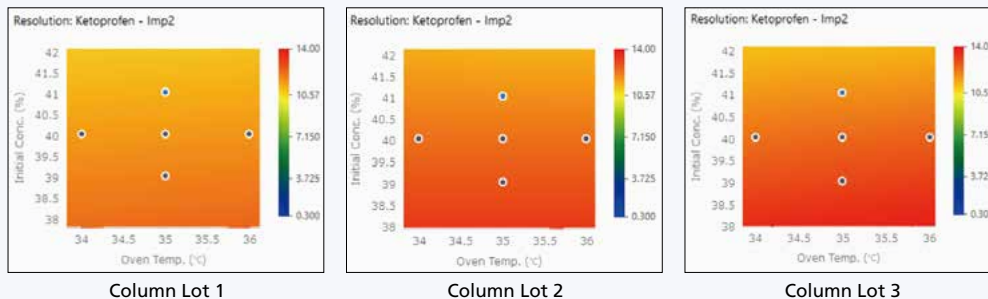

Automated Column and Mobile Phase Switching

In addition to automatically switching between multiple mobile phases and columns, mobile phase blending functionality can save labor by automating mobile phase preparation. LabSolutions MD is compatible with Nexera series and i-Series systems.

Nexera™ Series

These ultra-high-performance liquid chromatographs have a maximum pressure capacity of 130 MPa and support up to 192 combinations of 8 types of mobile phases and 12 types of columns (4 × 4 × 12).

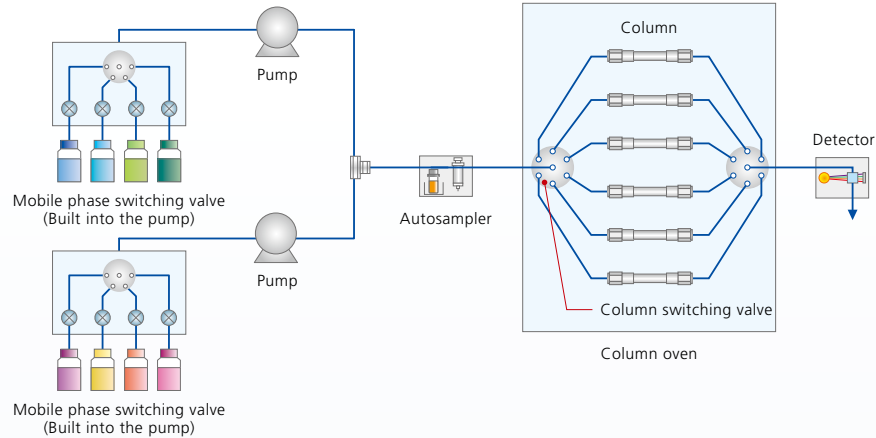

Nexera UC UHPLC / SFC Switching System

By switching LC and SFC in a single system, the optimum conditions can be determined efficiently. In SFC analysis, mobile phases can be automatically switched up to seven lines.

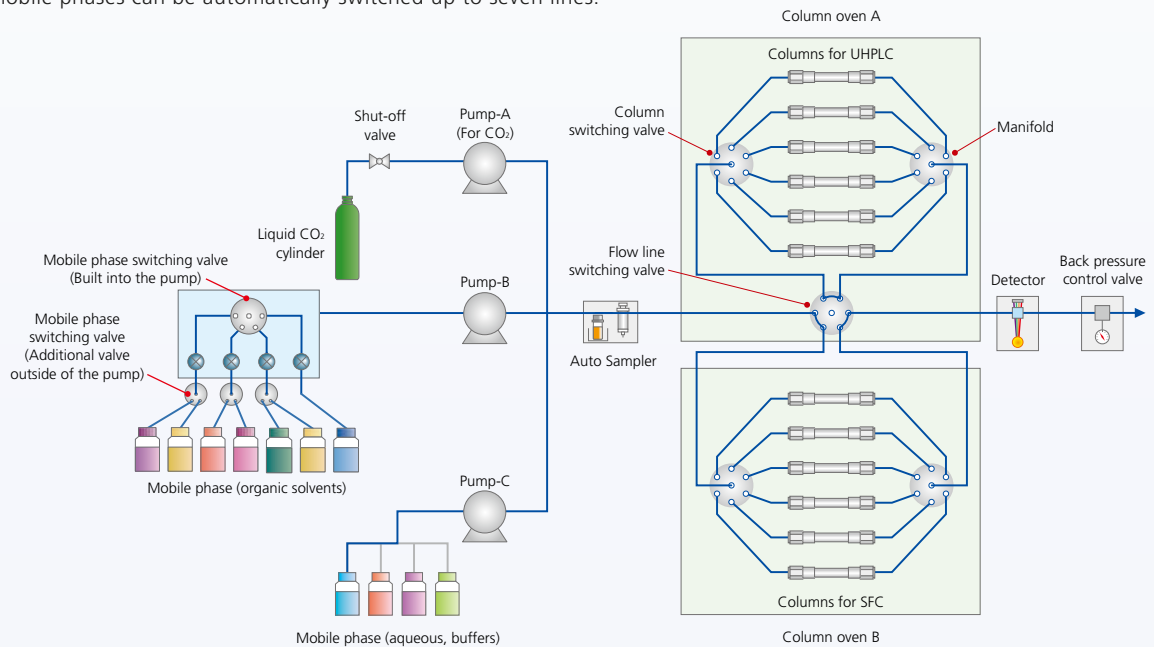

i-Series

This is an integrated LC system with a maximum pressure resistance of 70 MPa.

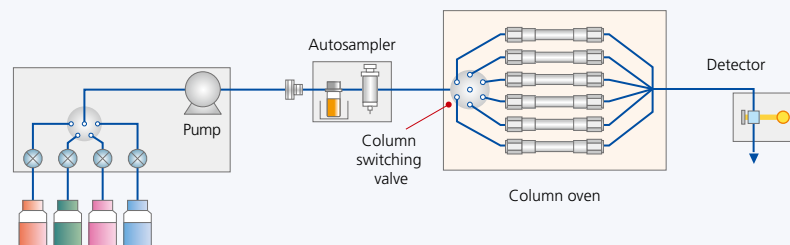

Maximizing Productivity with LCMS-2050



The single quadrupole LCMS-2050 combines revolutionary technology with the ease of use of an LC detector. This system features a wide mass range (m/z 2 to 2,000), a quick start as fast as six minutes, and easy, tool-free maintenance. It can fit into basic LC systems with its space-saving design. For details, refer to the catalog "LCMS-2050 Liquid Chromatograph Mass Spectrometer (C146-E442)".

[Brochure](#)

Ensure Data Integrity by Database Management

Not only can LabSolutions MD ensure data integrity by managing all the data in a single database of LabSolutions, it also enables seamless operation, such as creating an analysis schedule, running the analysis, and data processing using design space, for efficient method development to eliminate time-consuming file importing or exporting steps.

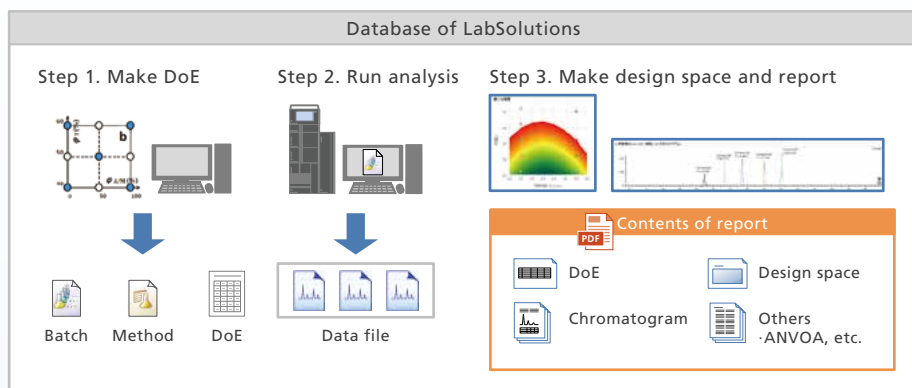

Column Kits for Reverse-Phase Analysis Method Development

C18 (ODS) columns have different resolution properties. A variety of C18 columns are included in the Shimadzu LC column Shim-pack series lineup. Shimadzu has bundled columns with different resolution characteristics into kits to make selecting candidate columns easier. These column kits are intended for reversed-phase analysis method development applications. In combination with LabSolutions MD, they enable more efficient column selection.

Kit types	HPLC	UHPLC	HPLC (LC-MS)	UHPLC (LC-MS)
① L1 Kit for HPLC C18 only	⊙			
② L1Kit for HPLC / UHPLC (LC-MS) C18 only	⊙	⊙	⊙	⊙
③ Maximum Selectivity RP Kit for HPLC / UHPLC Type A	⊙	⊙	○	○
④ Maximum Selectivity RP Kit for HPLC / UHPLC Type B	⊙	⊙	○	○
⑤ Maximum Selectivity RP Kit for HPLC / UHPLC (LC-MS)	○	○	⊙	⊙

*These column kits do not guarantee the appropriate separation for customer analyses. ⊙: Most suitable
○: Compatible

[Brochure](#)

List of LabSolutions MD Applications

- Efficient Method Development on Pharmaceutical Impurities Using Single Quadrupole Mass Spectrometer
- Efficient Method Development through Design Space Evaluation on Different Brands of Columns
- Efficient Method Development by Automated pH Screening with LabSolutions MD
- Efficient Method Development Based on Analytical Quality by Design with LabSolutions MD Software
- Efficient Method Development of Oligonucleotides by Reversed-Phase Ion-Pair Chromatography
- Efficient Method Development on Pharmaceutical Impurities Based on Analytical Quality by Design
- Efficient Method Development of Monoclonal Antibody Size Variants by Size Exclusion Chromatography

LabSolutions MD Package Contents

License of Method Development Solution

CD for installation (Instruction manual, Technical explanation)

"LabSolutions MD ~Automated Gradient
Optimization based on AI Algorithm~"

Brochure



LabSolutions, Analytical Intelligence logo, Shim-pack Scepter, Shim-pack, iPeakTracer, Nexera are trademarks of Shimadzu Corporation or its affiliated companies in Japan and/or other countries.



Shimadzu Corporation
www.shimadzu.com/an/

For Research Use Only. Not for use in diagnostic procedures.

This publication may contain references to products that are not available in your country. Please contact us to check the availability of these products in your country.

Company names, products/service names and logos used in this publication are trademarks and trade names of Shimadzu Corporation, its subsidiaries or its affiliates, whether or not they are used with trademark symbol "TM" or "®".

Third-party trademarks and trade names may be used in this publication to refer to either the entities or their products/services, whether or not they are used with trademark symbol "TM" or "®".

Shimadzu disclaims any proprietary interest in trademarks and trade names other than its own.

The contents of this publication are provided to you "as is" without warranty of any kind, and are subject to change without notice. Shimadzu does not assume any responsibility or liability for any damage, whether direct or indirect, relating to the use of this publication.