

Gas Chromatograph Mass Spectrometer

GCMS-TQ8050 NX

UFMS
ULTRA FAST MASS SPECTROMETRY



Ultra-High-Sensitivity Triple Quadrupole GC-MS for Pioneering New Fields

GCMS-TQ8050 NX

Equipped with a new, highly efficient detector and three forms of noise-reduction technologies, the GCMS-TQ8050 NX is capable of performing unprecedented quantitative analyses of ultra-trace amounts, down to the femtogram level.

Moreover, with its ultra-high sensitivity and high mass resolution, a whole new realm of quantitative analysis is offered, with reduced long-term operational costs and greater uptime.



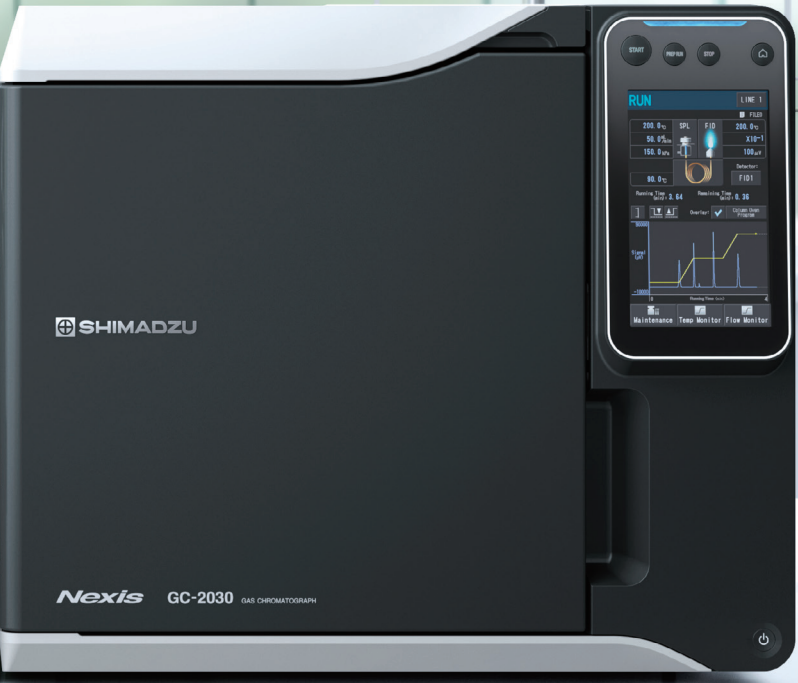

Enhanced Sensitivity

System That Detects Ultra-Trace Concentrations Not Previously Possible

To maximize the benefits of the Off-Axis Ion Optics, the system features three noise-reduction technologies and a detector with improved amplification performance. Due to these state-of-the-art technologies, the system can reliably detect ultra-trace femtogram-level quantities of ions. The resulting exceptional analytical sensitivity and robustness increase the value of solutions and open the door to new applications.

High-Efficiency Detector

The GCMS-TQ8050 NX detects peaks more reliably than the GCMS-TQ8040 NX, even for substances with fewer ions reaching the detector. That means it can reliably analyze femtogram-level concentrations with fewer ions.

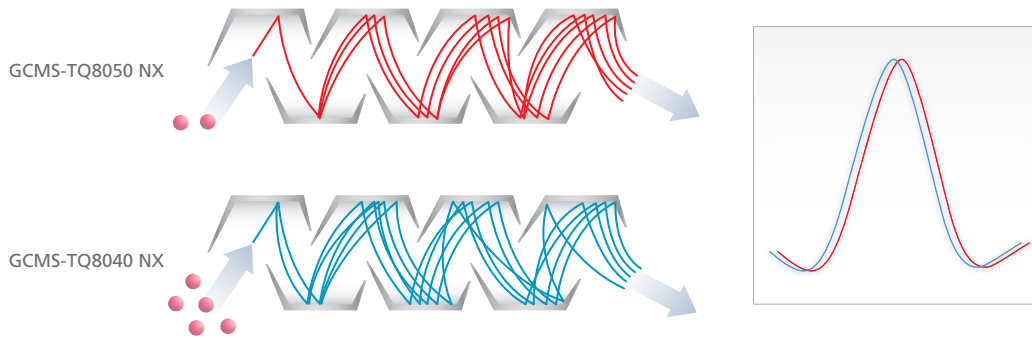

OFF-AXIS Ion Optics

The OFF-AXIS Ion Optics eliminate noises such as metastable He ions without compromising sensitivity.

Shielded Detector

Noise from outside the detector was reduced by installing a shield in the secondary electron multiplier.

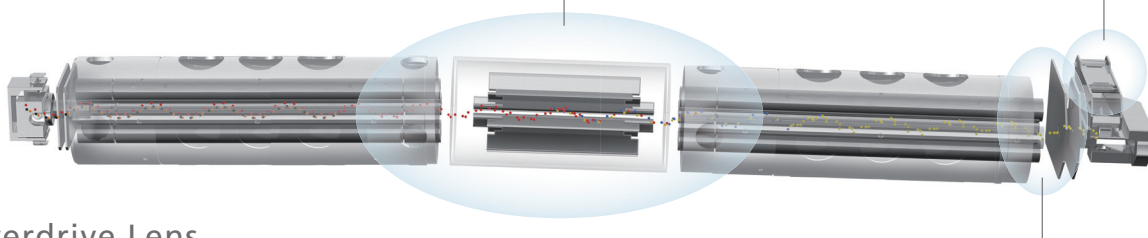

Overdrive Lens

Installing two lenses (overdrive lenses) in front of the electron multiplier reduces random noise from helium or argon and improves S/N. Applying voltage to the lenses improves S/N levels by reducing noise near the lenses and helping to focus the ions that pass through the mass filter (Patent No. US6737644).

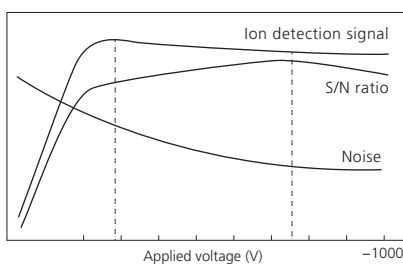

Relationship between voltage applied to overdrive lenses and S/N

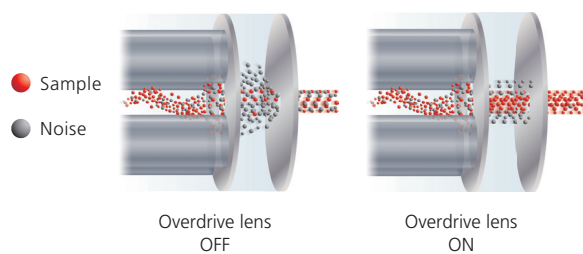

Noise reduction due to overdrive lenses

The newly designed high-sensitivity detector offers excellent reliability even for samples with femtogram-level concentrations of trace components, achieving sub-femtogram IDL* levels.

*IDL: Instrument Detection Limit

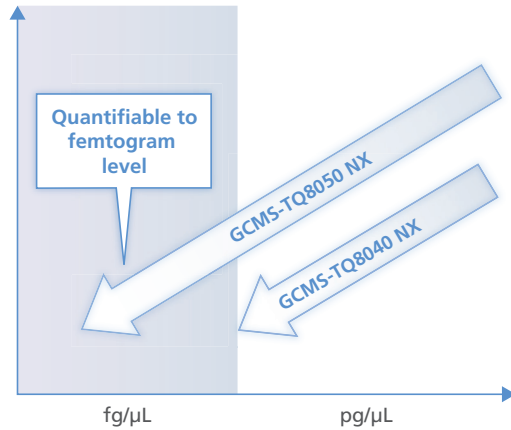
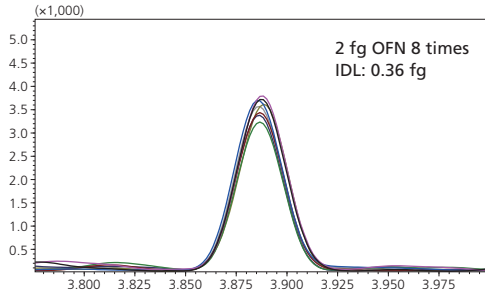

The superior data stability with the GCMS-TQ8050 NX provides sensitivity that rivals high-resolution GC-MS analysis. This powerful new analytical instrument reliably identifies peaks even for trace quantities of dioxins and other substances previously considered difficult to analyze using a quadrupole GC-MS system.

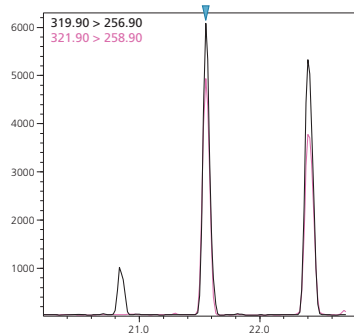

Mass chromatogram of 2,3,7,8-TeCDD (50 fg/μL)

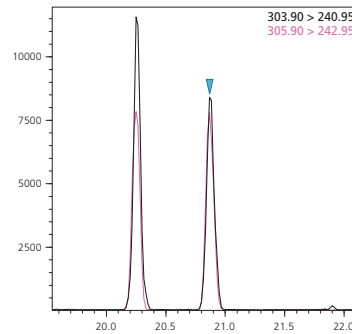

Mass chromatogram of 2,3,7,8-TeCDF (50 fg/μL)

Due to their tendency to resist degradation and remain inside organisms, the use of PFOS, PFOA, and other long-chain perfluorinated chemicals (PFCs) is increasingly being restricted. Because perfluorooctanesulfonamide and telomer alcohol have been identified as potentially breaking down to PFOS or PFOA, they have attracted attention as compounds that should be monitored in the environment, which involves monitoring trace concentrations.

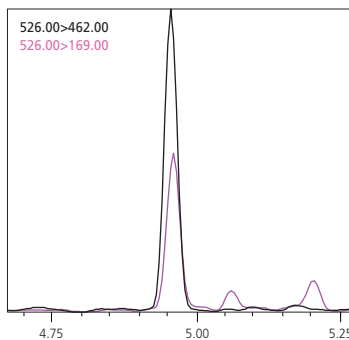

Mass Chromatogram of N-Me-FOSE (200 fg/μL concentration)

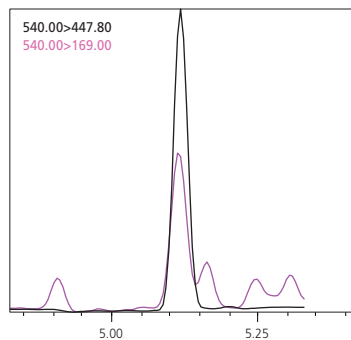

Mass Chromatogram of N-Et-FOSE (500 fg/μL concentration)

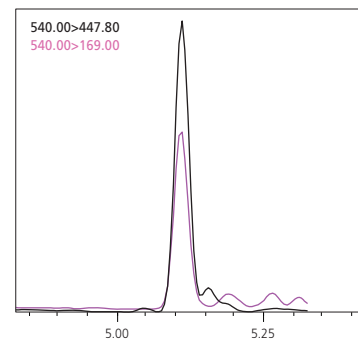

N-Et-FOSE in Polyester Sportswear (2.45 pg/μL quantitation value)

Durable Hardware

Reduces Maintenance Frequency and Long-term Operational Costs

In addition to ultra-high sensitivity, the GCMS-TQ8050 NX also offers high robustness. The contamination-resistant ion source and the new detector with over five times longer service life ensure that analysis can be performed reliably for a long time. With the ultra-high-sensitivity performance of the GCMS-TQ8050 NX, injection volumes can be reduced even further than before. The service life of inserts, columns, and other consumables can also be extended to reduce maintenance frequency and costs.

■ Highly Sensitive and Stable Ion Source

The effect of the filament's electric potential on the ion source is reduced by placing more distance between the filament and ion source box. In addition, a shield blocks out radiant heat generated from the filament to ensure the ion source box temperature remains uniform. Since this prevents any active spots within the ion source, it provides higher sensitivity for analysis.

(Patent: US7939810)

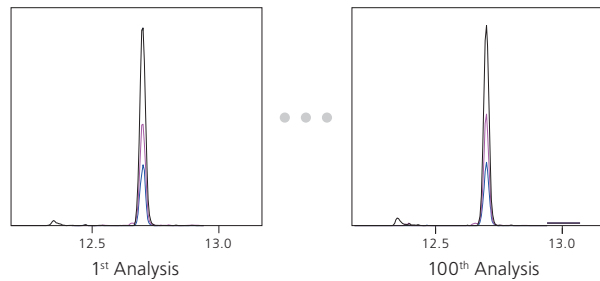
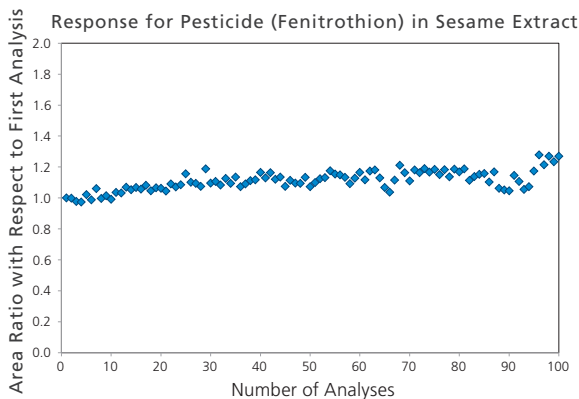
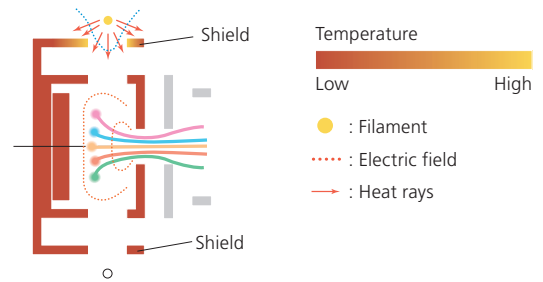

■ High-Performance Quadrupole Mass Filter

The high-accuracy mass filter with pre-rods and patented electric field control technology achieves high-accuracy mass separation performance.

Also, the pre-rods minimize quadrupole contamination and eliminate the need for quadrupole maintenance.

■ Long-Life Detector

Exhaustive efforts to reduce detector loads during analysis resulted in a significantly longer detector service life. Consequently, the instrument needs to be maintained much less frequently, which results in greater uptime.

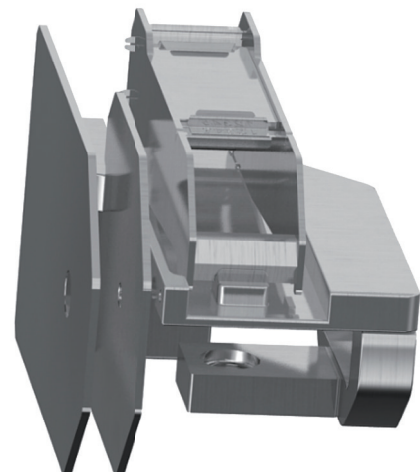

Because the GCMS-TQ8050 NX is able to detect ultra-trace ions with high sensitivity, it can also achieve high quantitative accuracy even from trace sample quantities. Therefore, injection volumes can be reduced during analysis to reduce the analytical loads on the insert, column, ion source, and other parts, and also further reduce maintenance frequency.

Previous model



2 µL injection of 5ng/mL

1/4 injection volume

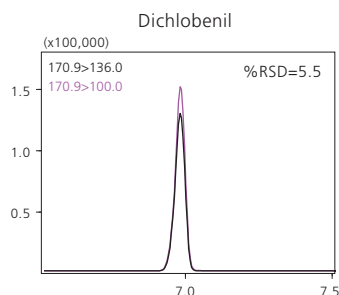

Number of times ion source maintenance is performed per year



1/4 cleaning frequency

Annual cost of consumables

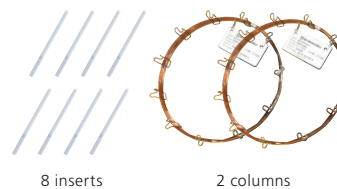

1/4 consumables cost

GCMS-TQ8050 NX



0.5 µL injection of 5 ng/mL

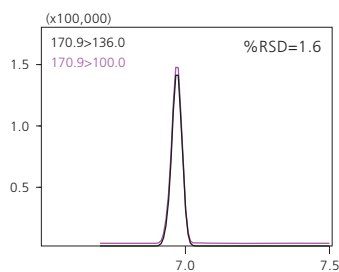

1 time per year



2 inserts



1 column

Oil-Free Pump (Optional)

The rotary pump can be replaced with an oil-free pump, which requires no maintenance for three years. This auxiliary vacuum pump not only maintains an oil-free environment inside the vacuum lines, it also eliminates the tedious and time-consuming tasks of replacing and disposing of the oil.

Clean exhaust due to dry method using no oil in the pump chambers

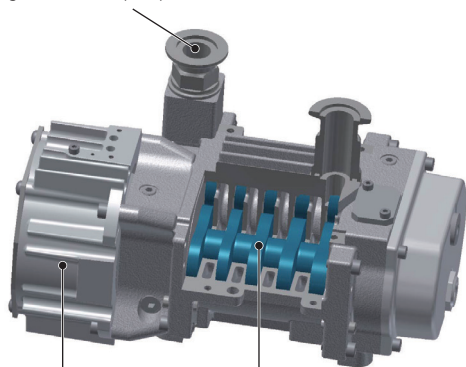

Air cooling method using no cooling water

Long life with no performance deterioration

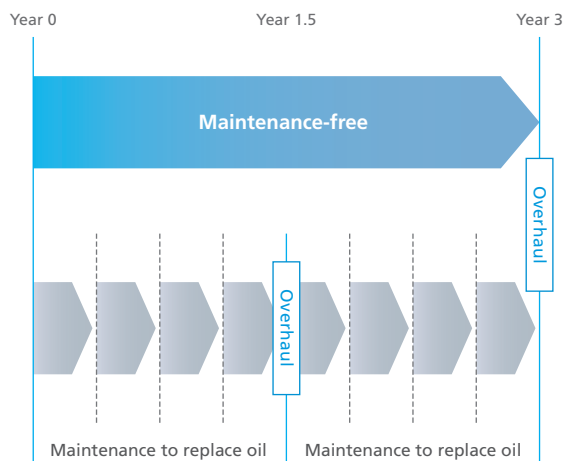

Superior Performance

High Efficiency for a Variety of High-Sensitivity Analysis

A new turbomolecular pump with higher evacuation performance achieves a superior vacuum state in the MS unit, which also provides high sensitivity in the single GC-MS mode. With the high-efficiency collision cell (UFsweeper) installed as before, high-sensitivity detection is possible even when mass resolution is increased.

The new active-time management function achieves further operating efficiencies by appropriately managing the wait times that occur during maintenance, while switching systems, or when the system is used by multiple users, to extend the operating time.

■ New Flow Controller Achieves Exceptional Reproducibility

A new flow controller (AFC) with a CPU uses various control methods to control carrier gas flow to a constant flow speed, flowrate, or pressure. It can also accurately trace the analytical conditions already being used.

In addition, the split line filter can be replaced without any tools. Internal contamination can be confirmed visually, ensuring filters are replaced at the proper time.

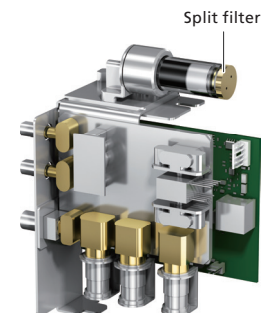

■ Advanced GC Oven

The improved temperature control function enables more precise temperature control of the GC oven, which improves the precision of retention time reproducibility.

In addition, three oven cooling rate levels can be specified to minimize damage to column liquid phases and maximize the service life.

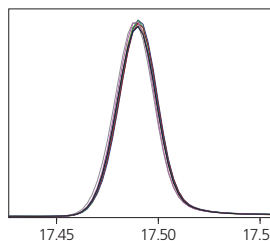

Mass chromatogram of benzo[a]pyrene
(Overlaid plotting of measurements repeated eight times)

	Area value %RSD	Retention time %RSD
Acenaphthylene	0.969	0.005
Fluorene	0.918	0.007
Phenanthrene	1.075	0.006
Anthracene	1.141	0.007
Pyrene	1.263	0.004
Benzo[a]anthracene	1.405	0.005
Chrysene	1.283	0.005
Benzo[b]fluoranthene	1.940	0.003
Benzo[k]fluoranthene	1.268	0.003
Benzo[a]pyrene	0.781	0.005
Indeno[1,2,3-cd]pyrene	0.744	0.004
Dibenz[a,h]anthracene	0.836	0.004
Benzo[ghi]perylene	0.767	0.004

Repeatability with polycyclic aromatic hydrocarbons (PAHs)

■ UFsweeper™ High-Efficiency Collision Cell

Shimadzu's proprietary UFsweeper technology efficiently sweeps residual ions out of the collision cell to achieve high CID efficiency and fast ion transport. That minimizes crosstalk and enables trace analysis.

The UFsweeper high-efficiency collision cell and Q1 unit with post-rods achieve outstanding ion transfer efficiency.



■ New Large-Capacity Differential Vacuum System

A more stable vacuum system was achieved by using a new turbomolecular pump that offers higher evacuation efficiency. Consequently, because it is able to maintain a high vacuum level even during MRM analysis with a collision gas (argon) introduced, it enables highly accurate trace analysis.

■ Detection with High Separation by High Mass Resolution

In many cases, even using MRM analysis does not provide sufficient separation for quantitative analysis of ultra-trace compounds in biological samples or food samples that contain large amounts of impurities, for example. Using the GCMS-TQ8050 NX, compounds can be detected with high sensitivity even if high mass resolution is specified. Therefore, it can clearly detect compounds that previously could not be separated from impurities.

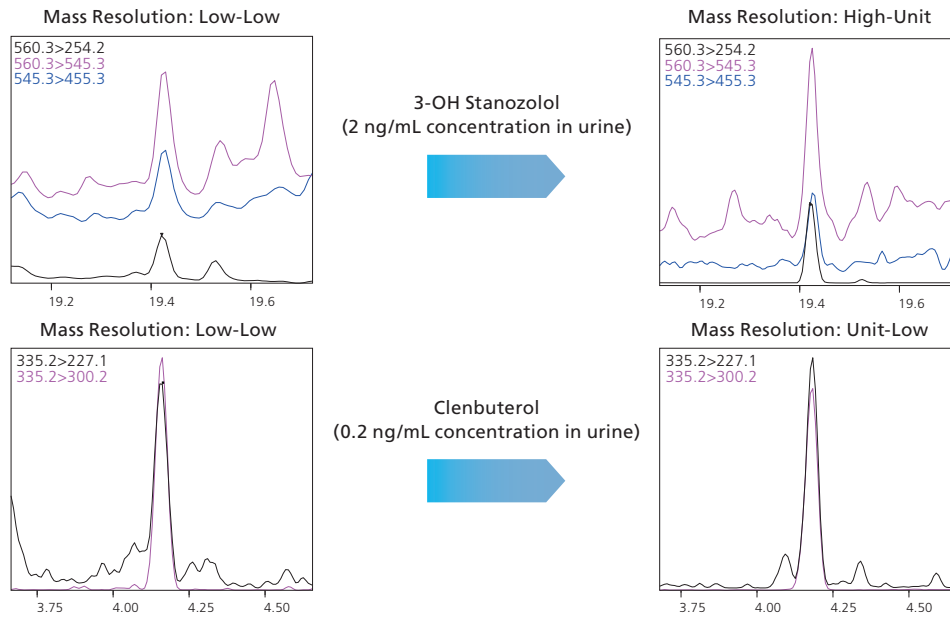

■ High-Sensitivity Analysis by Single GC-MS Mode

Due to a highly sensitive ion source and highly sensitive detector with overdrive lenses, the GCMS-TQ8050 NX is able to select and detect generated ions efficiently. That achieves high sensitivity not only for MRM measurements in the GC-MS/MS mode, but also for scan and SIM measurements in the GC/MS mode. In addition, pre-rods help prevent quadrupole contamination, so that stable sensitivity and mass spectra can be obtained even when samples containing many matrices are analyzed.

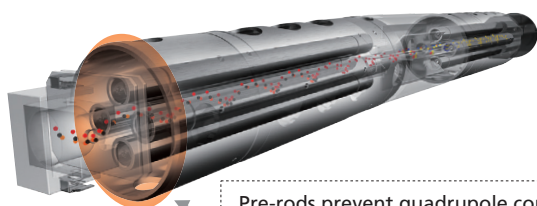

5 pg/mL Atrazine
Left: GCMS-QP2020 NX, Right: GCMS-TQ8050 NX
Reproducibility for n = 5

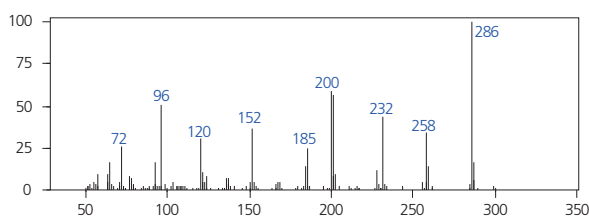

Scan Analysis Results for Butamifos

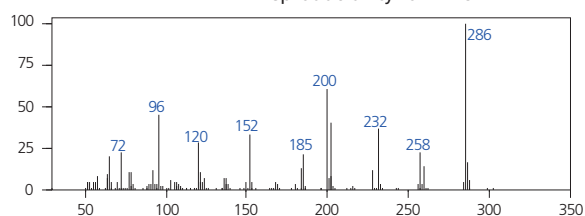

Mass Spectrum from NIST Library

■ Active-Time Management™ That Accurately Determines Operation Time

Time Management during Instrument Startup/Shutdown

The mass spectrometer has to be operated in a vacuum condition, the startup and stopping of the system takes time depending on the condition. Determining this can be a challenge. Since the amount of time that the system takes when starting up or stopping is displayed in real time, it is easy to accurately determine when maintenance of the ion source or analysis is possible. Moreover, tasks that until now needed to be performed by the user, such as leak checks upon system startup and auto tuning, are now performed automatically.

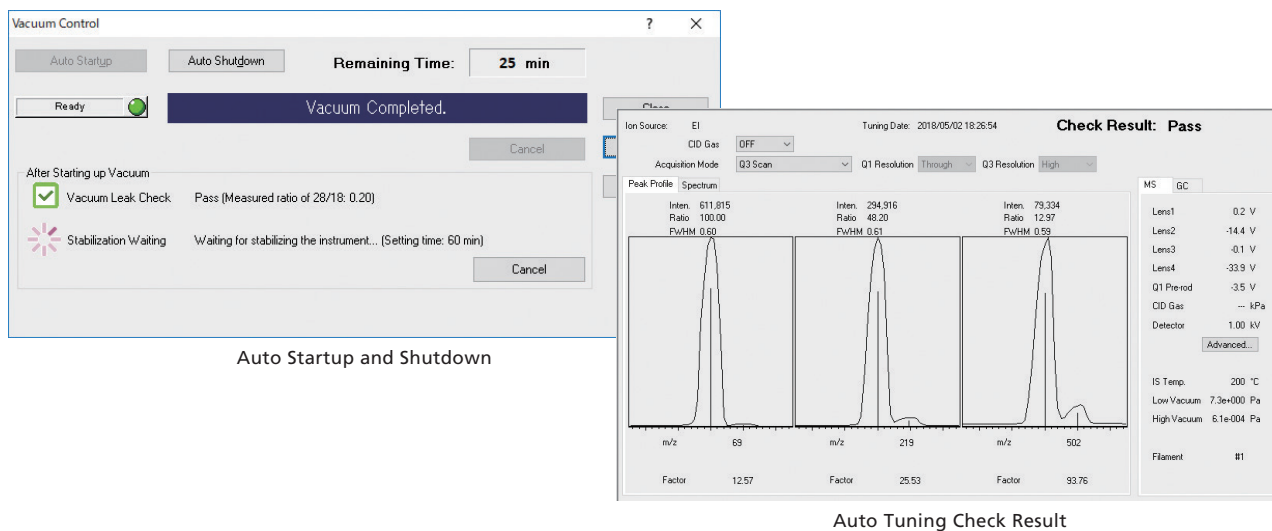

Time Management during Sample Injection Port Maintenance

The Easy sTop function, used to safely maintain the sample injection port without releasing the vacuum, displays the remaining time (cooling-down time) when the septum or the insert can be replaced in real time. Maintenance time can be minimized by understanding the accurate remaining time.

Furthermore, by using a ClickTek™ nut on the top of the sample injection port, the port can be opened or closed without tools, by simply using fingers to twist a lever. That enables faster and easier insert replacement than ever before.

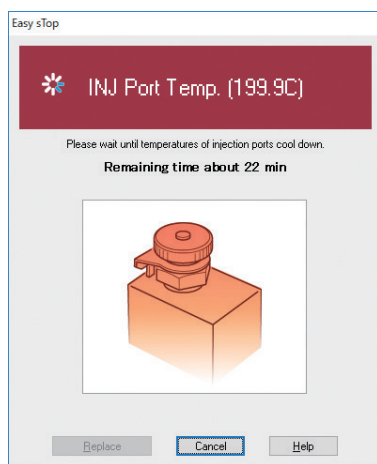

ClickTek Nut

Time Management for Continuous Analysis

By displaying the time required for continuous analysis in real time, the time when the current continuous analysis will finish can be accurately confirmed. This increases the instrument operating time (active time) by reducing standby time required during continuous analysis or while switching between different users. In addition, because this function makes it easier to schedule the timing for analysis preparations, such as sample preparation and pretreatment, based on the finish time of the previous analysis, it enables analytical processes to be performed more efficiently, which can help improve work-life balance.

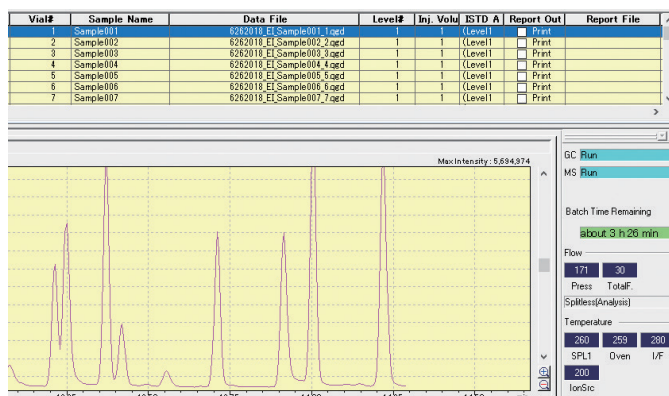

Time display for continuous analysis can be used only in liquid injection using AOC-20i.

Simple Column Replacement Using the Twin Line MS System

By connecting the outlet ends of two different columns to the MS at the same, different application data can be acquired without shutting OFF the MS vacuum. Since no flow restrictors are used, there are no losses from adsorption or other factors, and methods and retention times used for analysis with one column can continue to be used unchanged. The new large-capacity differential vacuum system ensures sensitivity does not decrease even when two columns are connected. Due to the separation from impurities and separation between isomers, the system can switch between different types of columns for measurements without actually replacing columns.

Twin Line MS System

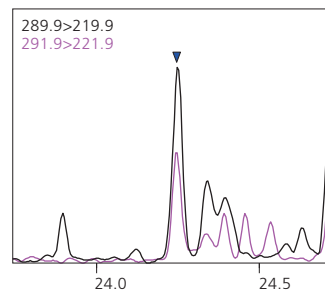

Example of PCBs Analysis in River Water
Column: SH-Rtx™-PCB (60 m, 0.25 mm, and 0.25 mm)
2,2', 5,5'-Tetrachlorobiphenyl (#52) (0.080 ng/L concentration in water)

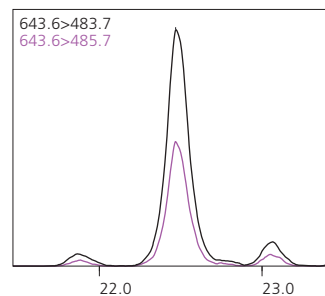

Example of PBDEs Analysis in Sediment
Column: SH-Rtx™-1614 (30 m, 0.25 mm, and 0.1 mm)
2,2', 4,4', 5,6'-Hexabromodiphenyl ether (#154)
(0.436 ng/g concentration in sediment)

Reliable Operation

Accurate Processes from Method Creation to Data Analysis

The Smart Database™ series, which are specialized for various fields, and Smart MRM™ function, which optimizes sensitivity, can be used to accurately create methods for ultra-trace analysis and reliably achieve high-sensitivity analysis from MRM measurements. LabSolutions Insight™ software, designed to support quantitative analysis of multianalyte data, enhances the throughput of data analysis from simultaneous analysis of multiple components in trace concentrations. The extensive accuracy control functions enable decisions to be made based on the easy-to-understand visualization of quantitative analysis and accuracy control results.

MRM Optimization Tool

■ Optimize MRM Transitions Automatically

Determining and optimizing MRM transitions for new compounds can require significant development time. The “MRM Optimization Tool” automates the process by collecting product ion scan data and finding the optimum collision energy for each transition.

Once established, the transitions are registered to one of the Shimadzu “Smart Database” files, and the MRM or Scan/MRM methods are created using **Smart MRM**.

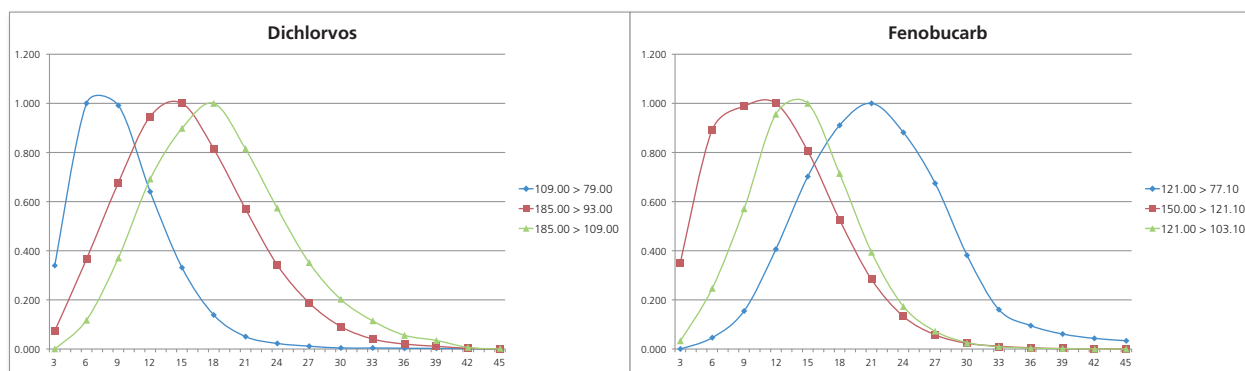

Smart Database

■ Method Management Achieved by Database File

The Shimadzu “Smart Database” is a database file for creating the method files using “Smart MRM” function. In addition to compound information and transitions, retention index can be registered in the database file. Method creation can be proceeded without calculating the retention time by analyzing the standard samples when using the Automatic Adjustment Retention Time (AART) function. In addition to MRM information, Scan and SIM ion information, mass spectra and calibration curve information from the internal standard method can also be registered in the database file. This allows users to create their own database easily.

Serial#	Type	Acq. Mode	ISTD Group	Level1 Conc (IS)	Method No.	Compound Name (E)	Ret. Index 1	Cas#	Ion1			
							Method1		Type	m/z	CE	Rati
1	Target	MRM			1	Aldicarb deg.	881	0 - 00 - 0	T	115.1>68.0	8	100.00
2	Target	MRM			1	DCIP	1058	108 - 60 - 1	T	121.1>45.0	4	100.00
3	Target	MRM			1	Aldoxycarb deg.	1135	0 - 00 - 0	T	80.0>65.0	6	100.00
4	Target	MRM			1	Chlofentezine deg.	1182	0 - 00 - 0	T	137.0>102.0	14	100.00
5	Target	MRM			1	Hymexazol	1196	10004 - 44 - 1	T	99.0>71.0	8	100.00
6	Target	MRM			1	Methamidophos	1236	10265 - 92 - 6	T	141.0>95.0	8	100.00
7	Target	MRM			1	Dichlorvos	1253	62 - 73 - 7	T	109.0>79.0	8	100.00
8	Target	MRM			1	Nereistoxin	1283	0 - 00 - 0	T	149.1>71.1	8	100.00
9	Target	MRM			1	Allidochlor	1296	93 - 71 - 0	T	132.1>56.0	8	100.00
10	Target	MRM			1	Dichlobenil	1358	1194 - 65 - 6	T	170.9>136.0	14	100.00
11	Target	MRM			1	EPTC	1364	759 - 94 - 4	T	189.1>128.1	4	100.00
12	Target	MRM			1	Biphenyl	1394	92 - 52 - 4	T	154.1>128.1	22	100.00
13	Target	MRM			1	Propamocarb	1398	24579 - 73 - 5	T	188.2>72.0	4	100.00

Smart MRM

Automatic Method Creation



The Smart MRM technology automatically creates methods with measurement times optimized for each component based on the Smart database. The Automatic Adjustment of Retention Time (AART) function incorporated in the system estimates retention times with high accuracy. When creating methods for simultaneous multicomponent analysis, the complicated process of configuring measurement parameters made it difficult to prepare appropriate methods. By using the Smart MRM function, however, it is possible to automatically create methods in which data are acquired with high sensitivity only during the elution time of the target components. In addition to MRM methods, SIM methods can be created.

MS Table Parameter

MRM, SIM Parameter

Loop Time (MRM, SIM)

Required Processing Time - R.T ±

Scan Mode ON OFF

Scan Parameter

Event Time of Scan:

Scan Range - Start m/z - End m/z: -

Acquisition Time: Start R.T. - End R.T.: -

OK Cancel

Parameter Setting

Automatic Adjustment of Compound Retention Time (AART) (Automatic Adjustment of Retention Time)

Compound Name (E)	Ret. Time
Pirimiphos ethyl	23.286
Isopropanol	23.415
Isodrin	23.436
Cyprodinil	23.458
Isofenphos-methyl	23.500
MGK 264-2	23.565
(E)-Chlorfenvinphos	23.629
Dimethametryn	23.715
Metazachlor	23.737
Pendimethalin	23.780
Heptachlor-epoxide	23.887
oxy-Chlordane	23.930
Chlozolinate	23.962
(Z)-Pyrifenoxy	23.962
Thiabenzazole	23.973
Allethrin-1,2	23.995
Phosfolan	24.016

Automatic Estimation of Retention Times

200 : Pirimiphos ethyl (3.3 ms)
201 : Isopropanol (3.3 ms)
202 : Isodrin (3.3 ms)
203 : Cyprodinil (3.3 ms)
204 : Isofenphos-methyl (3.5 ms)
205 : MGK 264-2 (3.5 ms)
206 : (E)-Chlorfenvinphos (3.3 ms)
207 : Dimethametryn (2.7 ms)
208 : Metazachlor (2.7 ms)
209 : Pendimethalin (2.7 ms)
210 : Ethylchlorazate (2.7 ms)
211 : Anirazine (2.5 ms)
212 : Penconazole (2.7 ms)
213 : Heptachlor-epoxide (2.7 ms)
214 : oxy-Chlordane (2.7 ms)
215 : Chlozolinate (2.7 ms)
216 : (Z)-Pyrifenoxy (2.7 ms)
217 : Thiabenzazole (2.7 ms)
218 : Allethrin-1,2 (2.7 ms)
219 : Phosfolan (2.5 ms)
220 : Tolytuand (2.7 ms)
221 : Heptachlor-endo-epoxide (2.7 ms)
222 : Bromfenvinfos-methyl (2.7 ms)

Dwell Time Optimization

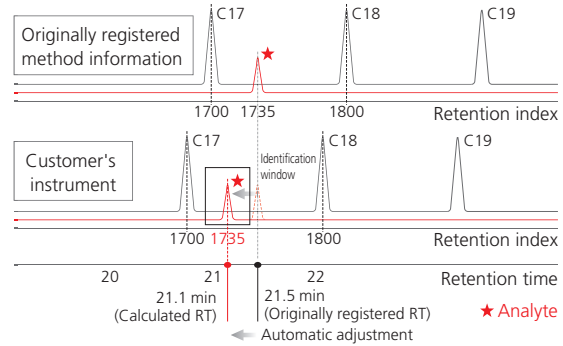

The AART function adjusts the retention times of target components based on linear retention indices (LRI) and the retention times of n-alkanes. The AART function easily adjusts acquisition and processing method parameters simultaneously.

Automatic Creation of Analysis Methods

Compound Name	Acq. Mode	Event Time(sec)	Ch1 m/z	Ch1 CE	Ch2 m/z	Ch2 CE	Ch3 m/z	Ch3 CE
44-14 MGK 264-2	MRM	0.018	164.10>98.00	12.00	111.10>82.00	8.00	164.10>67.00	8.00
44-15 (E)-Chlorfenvinphos	MRM	0.018	323.00>267.00	16.00	267.00>159.00	18.00	267.00>203.00	12.00
44-16 Dimethametryn	MRM	0.018	212.10>122.10	12.00	212.10>94.00	22.00	212.10>71.00	18.00
44-17 Metazachlor	MRM	0.018	209.10>132.10	18.00	133.10>117.10	24.00	211.10>132.10	20.00
45-1 Diphenamid	MRM	0.014	167.10>152.10	20.00	239.10>167.10	8.00	239.10>72.00	16.00
45-2 Fosthiazate-2	MRM	0.014	195.00>103.00	10.00	195.00>60.00	22.00	195.00>139.00	6.00
45-3 Pirimiphos ethyl	MRM	0.014	304.10>168.10	12.00	318.10>166.10	12.00	318.10>182.10	12.00
45-4 Isopropanol	MRM	0.014	280.10>238.10	8.00	280.10>133.10	18.00	280.10>165.10	16.00
45-5 Isodrin	MRM	0.014	192.90>157.00	20.00	192.90>123.00	26.00	262.90>192.90	28.00
45-6 Cyprodinil	MRM	0.014	224.10>208.10	16.00	224.10>197.10	22.00	224.10>131.10	14.00
45-7 Isofenphos-methyl	MRM	0.010	199.00>121.00	14.00	241.10>121.10	22.00	0.00>0.00	0.00
45-8 MGK 264-2	MRM	0.014	164.10>98.00	12.00	111.10>82.00	8.00	164.10>67.00	8.00
45-9 (E)-Chlorfenvinphos	MRM	0.014	323.00>267.00	16.00	267.00>159.00	18.00	267.00>203.00	12.00
45-10 Dimethametryn	MRM	0.014	212.10>122.10	12.00	212.10>94.00	22.00	212.10>71.00	18.00

Multianalyte Data Analysis with More Efficiency Using LabSolutions Insight

LabSolutions Insight quantitative analysis support software includes functionality for enhancing the throughput of multianalyte data analysis, making it especially helpful for routine analysis. Quantitative results for a series of data sets can be displayed at the same time for data analysis. Chromatograms for each set of sample data can be displayed side-by-side for each compound, making it easy to confirm peak detection and quantitative results. Color-coded flagging functionality makes it easy to quickly see peaks from any of multiple analytes that exceed criteria values. That drastically decreases the number of peaks that need to be checked and improves the efficiency of quantitative analysis processes.

More Efficient Multianalyte Data Analysis

Users can select the optimal method for displaying data based on their workflow. For example, data analysis windows can be displayed for each target compound or each set of measurement data, or quantitation or area values can be displayed as a list. If necessary, quantitative analysis can be repeated with peaks directly corrected, which provides intuitive operability.

Visualization of Quantitative and Accuracy Control Results

Quantitative and accuracy control results can be presented more clearly by using the flagging function to color-code result values that exceed specified criteria values or by only displaying flagged results. Five levels of criteria values can be indicated for quantitative results, making it easy to confirm the corresponding criteria value range for the detected compounds. Flagging immediately reflects results from any corrections made to manual peak integration or calibration curves.

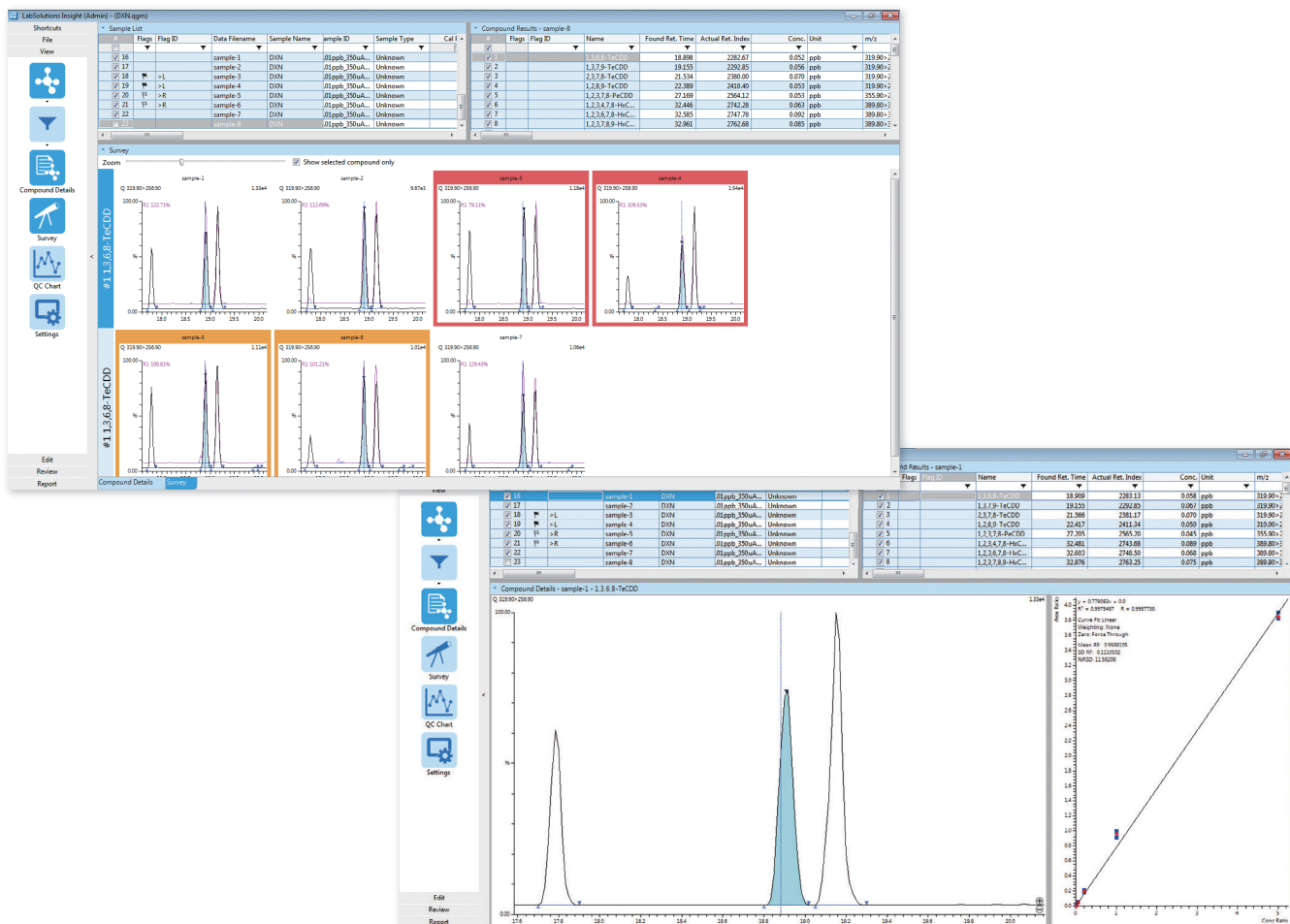

■ Easy Control of Quantitation and Reference Ions

Analysts can update retention times and reference ion ratios quickly and easily from a single standard or a group of standards. It is also easy to reassign quantitation ions as needed for method development purposes or because of unexpected matrix interferences.

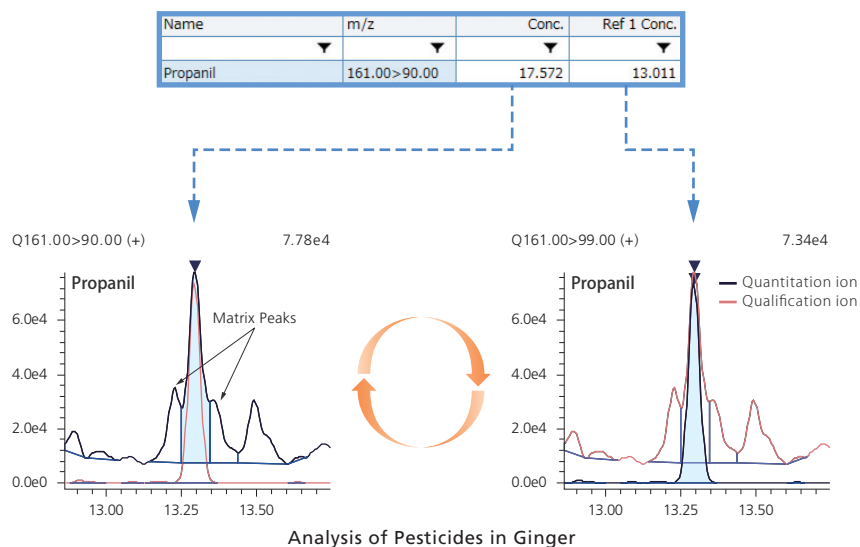

■ Status Review Function

This function can be used to specify the status of all compounds and samples for their management. By specifying a status, the progress of data analysis work can be accurately recorded and reported.

#	Flags	Data Filename	Status	Sample Type	#	Name	Status
<input checked="" type="checkbox"/>		Conc-3_001	Pending	Standard	<input checked="" type="checkbox"/>	MPA-gluc	Pending
<input checked="" type="checkbox"/>		Conc-3_002	Accept	Standard	<input checked="" type="checkbox"/>	d3-MPA-...	Pending
<input checked="" type="checkbox"/>		Conc-3_003	Review	Standard	<input checked="" type="checkbox"/>	MPA	Pending
<input checked="" type="checkbox"/>		Unknown-1	Rerun	Unknown	<input checked="" type="checkbox"/>	d3-MPA	Pending

■ Network Support

Data acquired from multiple systems can be reviewed or confirmed using client computers connected via a LAN or other network. If multiple systems are used, data obtained from each system can be reviewed from any client computer. Even in the case of multiple analysts using the same system, the ability to separate analytical work from measurement work improves efficiency.

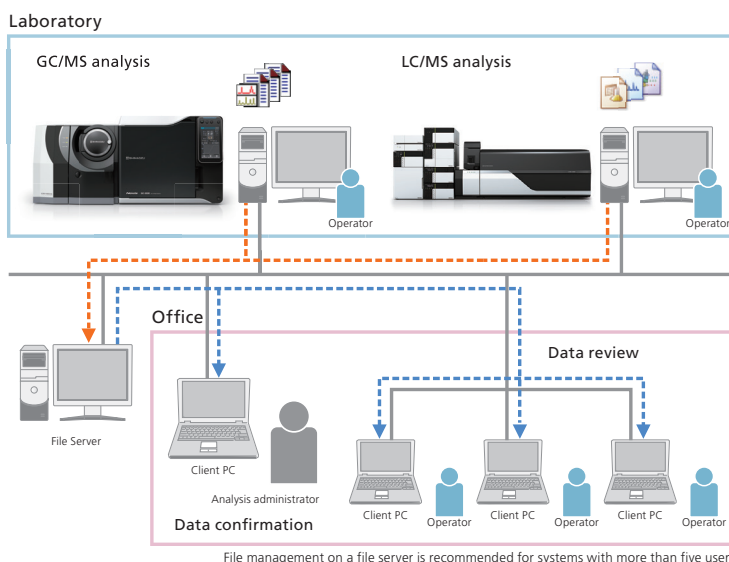

File management on a file server is recommended for systems with more than five users.

Smart Database Series Supporting Accurate Quantitative Determinations in MRM Analysis

The series contains optimized analysis conditions, so users can start an analysis immediately without investigating the conditions. This database is for accurate quantitative determinations using standard samples.

● Smart Pesticides Database™

It covers the pesticides (530 compounds) subject to GC-MS analysis and used inside and outside Japan. The database also contains information on compounds that can be used as internal standards. Therefore, it also supports analysis with the internal standard method.



● Smart Metabolites Database™

The database contains 525 compounds including metabolites contained in blood, urine, cells and other biological samples. It also contains information on the stable isotopes of 22 major metabolites, which can be used as internal standards.



● Smart Environmental Database™

The database contains information on 527 compounds including polychlorinated biphenyl, brominated flame retardants, dioxins, polycyclic aromatic hydrocarbons, and organochlorine pesticides, as well as their stable isotope labeled compounds.



● Smart Forensic Database™

The database is registered with 486 forensic toxicological substances often involved in poisonings, such as drugs of abuse, psychotropic drugs, pharmaceuticals, and pesticides.



In particular, the "Smart Environmental Database" is extremely useful for analysis of environmental pollutants, which require trace analysis.

Not only are MRM information and stable isotope labeled compounds (IS) for target analysis components registered in the Smart Environmental Database, but also the optimal columns for separating each compound are set, so trace analysis can be performed without having to set the conditions for each compound.

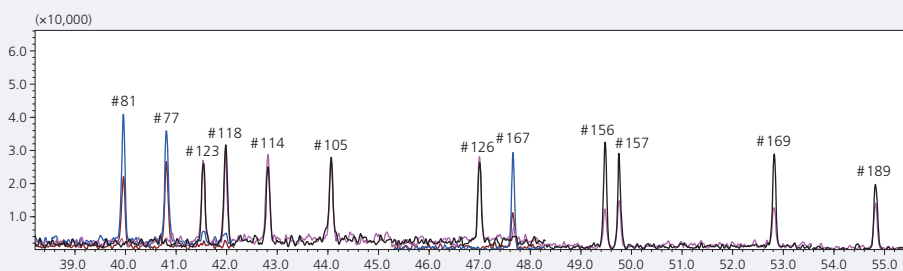

Dioxin-Like PCBs (50 fg/μL concentration)

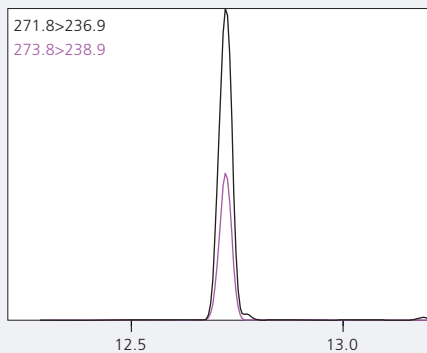

Heptachlor (50 fg/μL concentration)

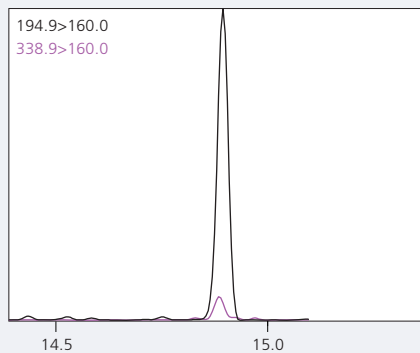

alpha-Endosulfan (50 fg/μL concentration)

Inert Flow Path Achieves High-Sensitivity GC/MS Flow Path

Minimizing adsorption and other losses in the flow path from sample injection to the detector is important for stable, high-sensitivity measurements using GC/MS. The flow lines in the GCMS-QP series and the TQ series consist of high-quality, highly reliable consumable parts, so even trace concentrations of components can be detected with high sensitivity and favorable repeatability.

Glass liner

The glass liner recommended for GC/MS analysis uses a proprietary inactivation technology to dramatically suppress active sites. After packing into the insert, the wool is subjected to a complete inactivation treatment. This product is controlled throughout from production to final inspection to provide 100 % satisfaction.

TIC	Resolution (%)	Endrin	p,p'-DDD	p,p'-DDT
	Endrin: 1.34			
	DDT: 1.44			

Micro-syringe

Autosampler syringes feature improved durability, clarity, and accuracy, achieving reliable injection accuracy.

GC septum

Our lineup now includes low bleed septa, which maintain optimal seal performance even when the injection cycles are increased, and can be used even at high temperatures. This reduces sensitivity variations due to leaks.

Ferrules and gold gasket

The high-quality Vespel ferrule is easily attached and designed to resist leaking. The gold gasket is inactive, and adsorption does not occur.

Ion source

Designed with a shield that blocks radiant heat generated by the filament, and an ion source treated with an oxide coating, active spots inside the ion source are not prone to occur, which enables high-sensitivity analysis with long-term stability.

Capillary columns

For the SH-Rxi™ series, a high-quality fused silica like no other is used as the raw material. Our proprietary surface inactivation technology and optimal process to mask silanol groups result in a low-bleed column with very impressive inactivation performance, even with respect to polar compounds comparable to acidic and basic substances.

Wide Variety of Optional Products for Supporting Trace Analysis

■ Chemical Ionization and Negative Chemical Ionization

In addition to commonly-used electron ionization (EI), both chemical ionization (CI) and negative chemical ionization (NCI) are available for the GCMS-TQ8050 NX. The CI mode is a "soft ionization" technique, used to detect many compounds not possible by EI, and is suited for confirmation of molecular weight. The NCI mode can be used to detect functional groups having a high electron affinity such as halogens. Any of three types of reagent gases (methane, isobutane, or ammonia) can be used.

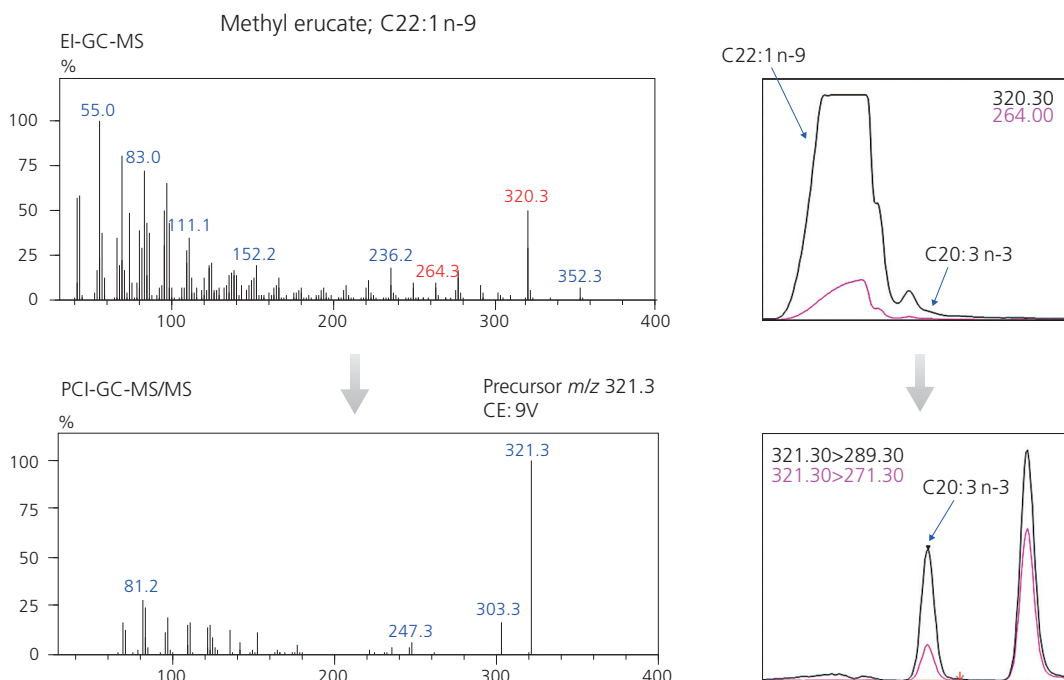

A type of female hormone, estrogen persists in the environment at low concentrations as an endocrine disruptor, which requires high sensitivity for analysis.

To analyze estrogen, it is first derivatized and then a GC/NCI-MS system is used to selectively analyze compounds with high electron affinity.

The GCMS-TQ8050 NX proves its worth in ultra-trace analysis using not only EI, but CI and NCI ionization methods as well. In particular, the GCMS-TQ8050 NX can analyze femtogram-level concentrations of estradiol, which is one type of estrogen, with high sensitivity and accuracy using NCI. Therefore, it eliminates the previously required step of first concentrating samples.

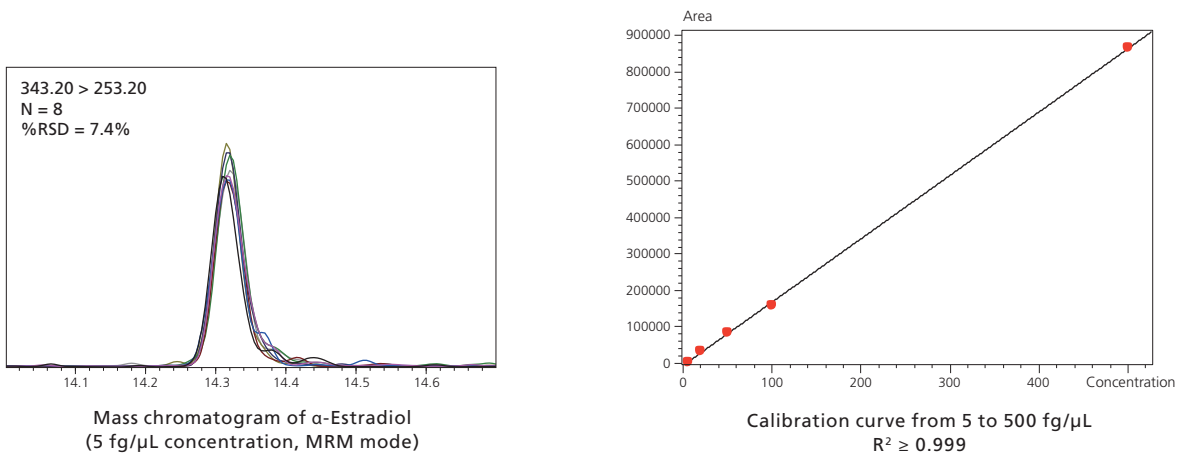

■ AOC-6000 Multifunctional Autosampler System

The AOC-6000 supports three sample injection methods: liquid sample injection, headspace (HS) injection, and solid phase micro extraction (SPME) injection, so samples in a variety of forms can be analyzed. It allows the sample injection method to be switched automatically, enabling different sample injection methods to be combined in a continuous operation.

With the automatic syringe exchange and stirring function, standard samples can be prepared automatically with a variety of dilution levels, and everything from the creation of calibration curves to the quantitative determination of unknown samples can be fully automated.

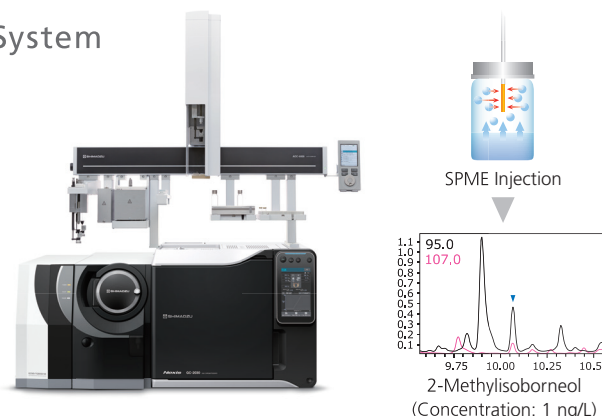

■ HS-20 Headspace Analysis System

The HS-20 headspace sampler provides strong backup for the analysis of volatile components at every stage from research to quality control departments. The high-sensitivity electronic cooling trap enables quantitative and qualitative determination of trace components that cannot be detected with a conventional headspace sampler.

The HS-20 transfer line is built into the GC unit, which makes it easy to combine the HS-20 with the AOC-20 liquid sample injector, as well as to switch between these units.



■ OPTIC-4 Multimode Sample Inlet System

The OPTIC-4 multimode sample inlet is a GC injection port that enables a variety of sample injection modes for GC-MS, including large-quantity injection, inlet derivatization, thermal desorption, and DMI (difficult matrix introduction).

Combining this with an autosampler enables automatic replacement of inserts, improving productivity in multisample analyses.



■ TD-30 Thermal Desorption System

Thermal desorption systems heat samples in a sample tube and then concentrate the thermally desorbed gases before injection into a GC-MS. They are commonly used to measure volatile organic compounds (VOCs) in the atmosphere or measure trace components that are generated from plastic or other samples.

The TD-30R can accommodate 120 samples for excellent processing capacity and offers outstanding expandability, such as functionality for retrapping components or for automatically adding an internal standard substance.



GCMS-TQ, UFMS, UFSweeper, Active Time Management, ClickTek, Smart Database, Smart MRM, LabSolutions Insight, Smart Pesticides Database, Smart Metabolites Database, Smart Environmental Database, Smart Forensic Database and AOC are trademarks of Shimadzu Corporation.
Rtx and Rxi are registered trademarks of Restek Corporation.



Shimadzu Corporation
www.shimadzu.com/an/

For Research Use Only. Not for use in diagnostic procedures.

This publication may contain references to products that are not available in your country. Please contact us to check the availability of these products in your country.

Company names, products/service names and logos used in this publication are trademarks and trade names of Shimadzu Corporation, its subsidiaries or its affiliates, whether or not they are used with trademark symbol "TM" or "®".

Third-party trademarks and trade names may be used in this publication to refer to either the entities or their products/services, whether or not they are used with trademark symbol "TM" or "®".

Shimadzu disclaims any proprietary interest in trademarks and trade names other than its own.

The contents of this publication are provided to you "as is" without warranty of any kind, and are subject to change without notice. Shimadzu does not assume any responsibility or liability for any damage, whether direct or indirect, relating to the use of this publication.